



TONALITY[®]
NATURAL FACADES



TONALITY[®]
Ceramic Facades.
Building Innovation.



ARCHITECT | TURNER, Sydney, AU
OBJECT | Sanctuary at Wentworth Point, Sydney, AU
PHOTOGRAPHY | Tom Ferguson Photography
COLOR | Bright red, Anthracite, Kimura beige
SURFACE | smooth

Contents.

BUILDING ON HISTORY

A tradition of innovation	6
Strong together	8

BUILDING SUSTAINABLE VALUE

Quality through MCS	12
Sustainability at the highest level of safety	14

BUILDING SUSTAINABLE FUTURE

The facade of the future	18
--------------------------	----

BUILDING ADVANTAGES

Advantages	22
The rear-ventilated ceramic facade	24
Two systems for all installation requirements	25

BUILDING TAILORED SOLUTIONS

Every facade is like a tailor-made suit	30
Individuality on the facade	34
Natural privacy and sun protection	38
Inspired by nature	40
Custom-made architecture	42
Natural design	44

BUILDING REFERENCES

The Wave Apartments, Denmark	48
Vesalius Residential Complex, Belgium	52
Office Data Centre, Canada	56
Maggie's Centre, United Kingdom	60
Robert-Junck Comprehensive School, Germany	64
Sparkasse Duisburg, Germany	68
Dahl Law Firm, Denmark	72
Pertinsel Children's House, Austria	76
Forfatterhuset Kindergarten, Denmark	80
Toowong Train Station, Australia	84
Sanctuary, Australia	88
Velliv Office Building, Denmark	92



4

5

**Building
on history**

0.1

„Combining natural building materials with future-oriented action and thinking: This is our ambition.“

As part of the LEIPFINGER-BADER Group, we are among the leading manufacturers of building materials and system components for climate-neutral construction. We consider ourselves as innovation drivers with a clear focus on ecologically sustainable products and a reliable partner to our customers.

Our strong local ties are also reflected in our love of natural raw materials. We have been processing naturally occurring clay for decades. At our location in Weroth (Westerwald), we extract Europe’s finest clays and process them into a high-end building material using our state-of-the-art production facilities. TONALITY has produced ceramic facade solutions for some of the most architectural significant buildings in the world such as the Wave, Copenhagen, DK.

We are convinced that we must reduce material consumption for environmentally friendly buildings with a healthy indoor climate. Therefore, we attach particular importance to continuous circular economy in everything we do, making us one of the trendsetters in the industry.

TONALITY® recognised as a TOP 100 Innovator.



Award-winning innovation work: TONALITY was awarded the Top Innovator 2022 seal in the 29th round of the TOP 100 competition. The key part of the innovation competition is a scientific selection process that examines and assesses more than one hundred innovation indicators in small and medium-sized businesses. We are proud.

- ▼ Owner Thomas Bader has been managing the LEIPFINGER-BADER Group since 2006. The brick factory has developed to become one of the most innovative and future driven system provider in the building industry, especially as a result of the acquisition of TONALITY GmbH and the development of energy-efficient products. „The driving force behind my daily work is to find forward-looking solutions for new construction and refurbishment projects, that make it possible to transform the building industry in the long term“, said Thomas Bader.



ARCHITECT | Schwarz Architekturbüro, DE
 Architekt M.A. (TUM) Bernd-Simon Schwarz, DE
OBJECT | Innovative office building in Munich-Gräfelfing, DE
PHOTOGRAPHY | Heiko Stahl



Strong by itself. Even stronger together.

Whether in new construction or refurbishment, LEIPFINGER-BADER offers integrated solutions for sustainable buildings of today and tomorrow.

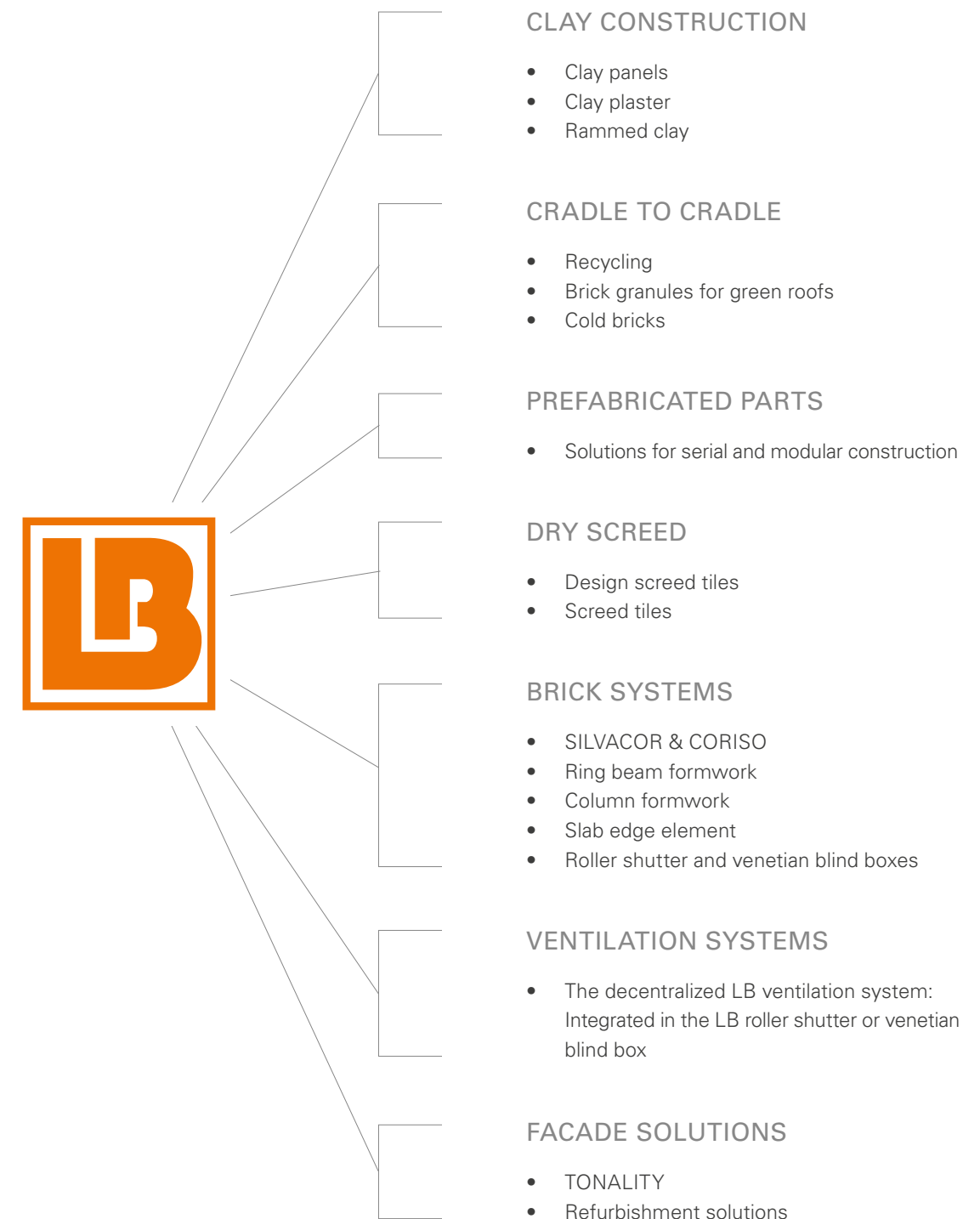



**Building
sustainable value**

0.2

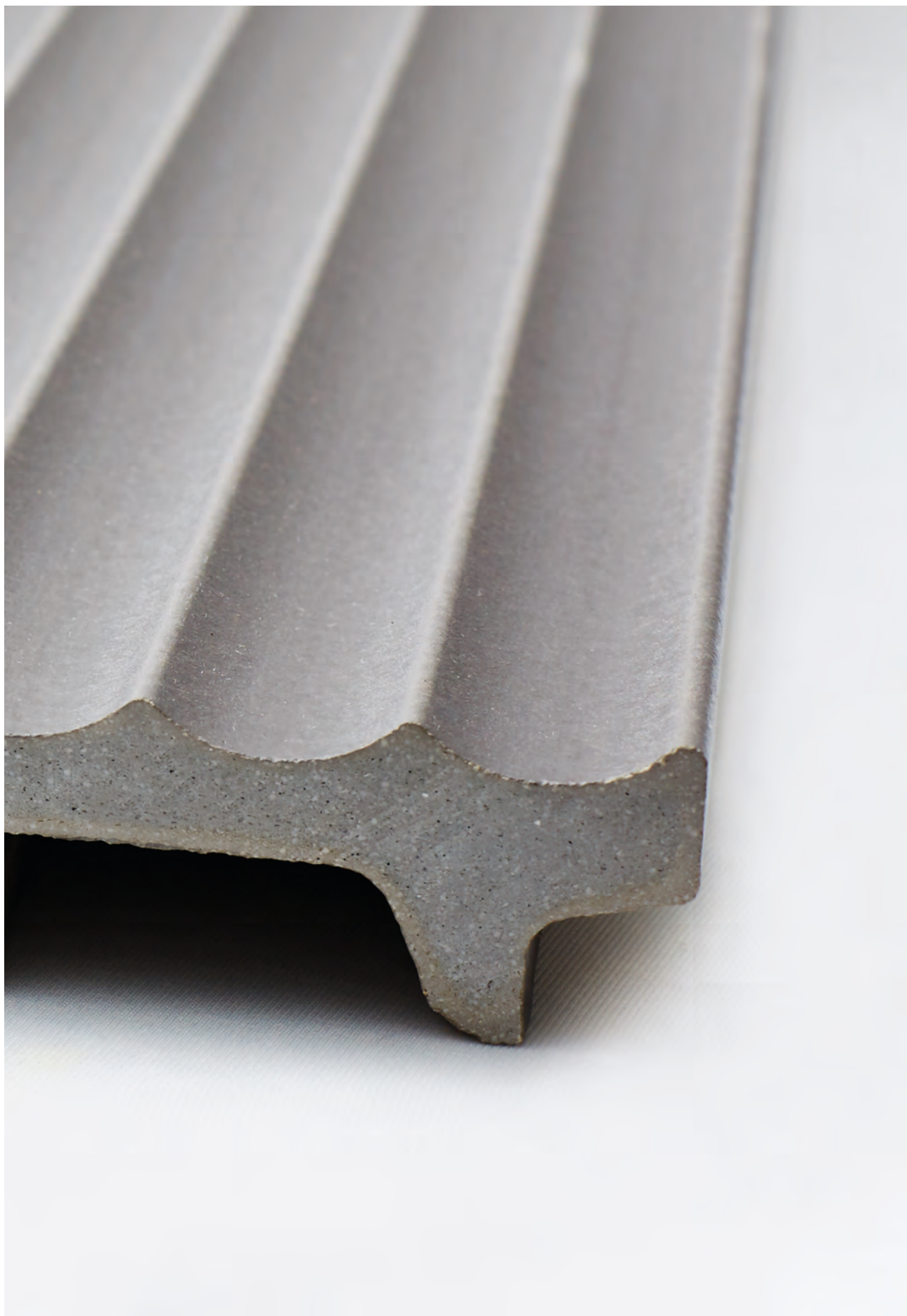

Quality through MCS – turning clay into a ceramic element.



01 MICRO-PROCESSING THE CLAY

Our work begins at a very fine level: The first step consists in grinding the clay to a grain size of 64 micrometres (0.064 millimetres). The fireclay used is also ground until it is ultra-fine. Both raw materials are then placed in the press.

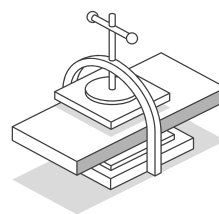

02 WORK AT HIGH PRESSURE

With the aid of our vacuum extrusion process, the desired ceramic element is compressed at high pressure. The fine processing of the clay and fireclay in combination with a high applied pressure guarantees a high level of solidity.

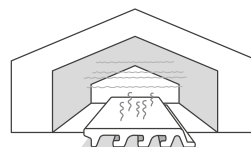

03 HOMOGENEOUS DRYING & HOT-GLAZING PROCESS

In the next step, the ceramic elements are dried and glazed. Specially designed roller dryers ensure homogeneous drying. The traditional, digitally controlled hot-glazing process gives the final product the desired surface.

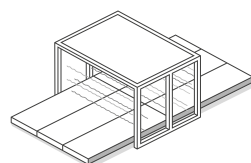

04 SINTERING – NOW THINGS REALLY HEAT UP

Thanks to maximum temperatures of up to 1,200 °C, the ceramic elements can be fired to the point of sintering. The material, which has already been heavily compressed, is compacted even further. All raw materials are fused together.

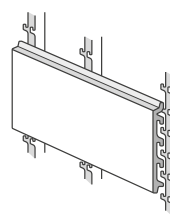

- ▼ A total of 391 modules form the five- to six-storey administrative building for over 600 people. The backbone of the building complex is formed by a six-storey longitudinal bar that has perpendicular four- to five-storey wings on both sides. This special structure reflects the campus character, which is primarily due to the large amount of space required. At the same time, this floor plan also allows all offices to face outward. **„We were impressed not only by the special design combined with integrated graffiti protection, but also by the great flexibility of the facade system”,** says Jörg Löber, Managing Director of ALHO Systembau GmbH.



ARCHITECT | ALHO Systembau GmbH, Friesenhagen, DE
 OBJECT | Agentur für Arbeit, Cologne, DE
 PHOTOGRAPHY | Martin Lässig, DE
 COLOR | Brick red (natural)
 SURFACE | smooth

Sustainability at the highest level of safety.



01 RESISTANT AND ROBUST

UV- and frost-resistant – regardless of weather and thermal influences, such as salty sea air or sandy breezes. Thanks to their outstanding hardness, TONALITY ceramic facades are impact- and scratch-proof – and are characterized by colourfastness and dimensional stability. TONALITY facades require no maintenance and last well over 100 years.



02 FUTURE DRIVEN

100% natural. No use of composite materials, plastics or chemicals. The natural advantages of Westerwald clay are so impressive that there is no need for additives. This is beneficial to both human health and the environment.



REUSE

03 RE-USE AFTER USE

Facade elements including the supporting structure can be used in other projects according to the re-use principle, eliminating additional CO₂ emissions caused by recycling.



04 RESOURCE-EFFICIENT

With our single-layer, lightweight ceramic facades, we need about 20 tonnes less clay and fireclay for a facade surface of 1,000 m². All clays and fireclays come from within a radius of no more than 25 km around our production site, saving valuable resources and energy from raw material extraction and production to transport to the building site.



**Building
sustainable future**

0.3

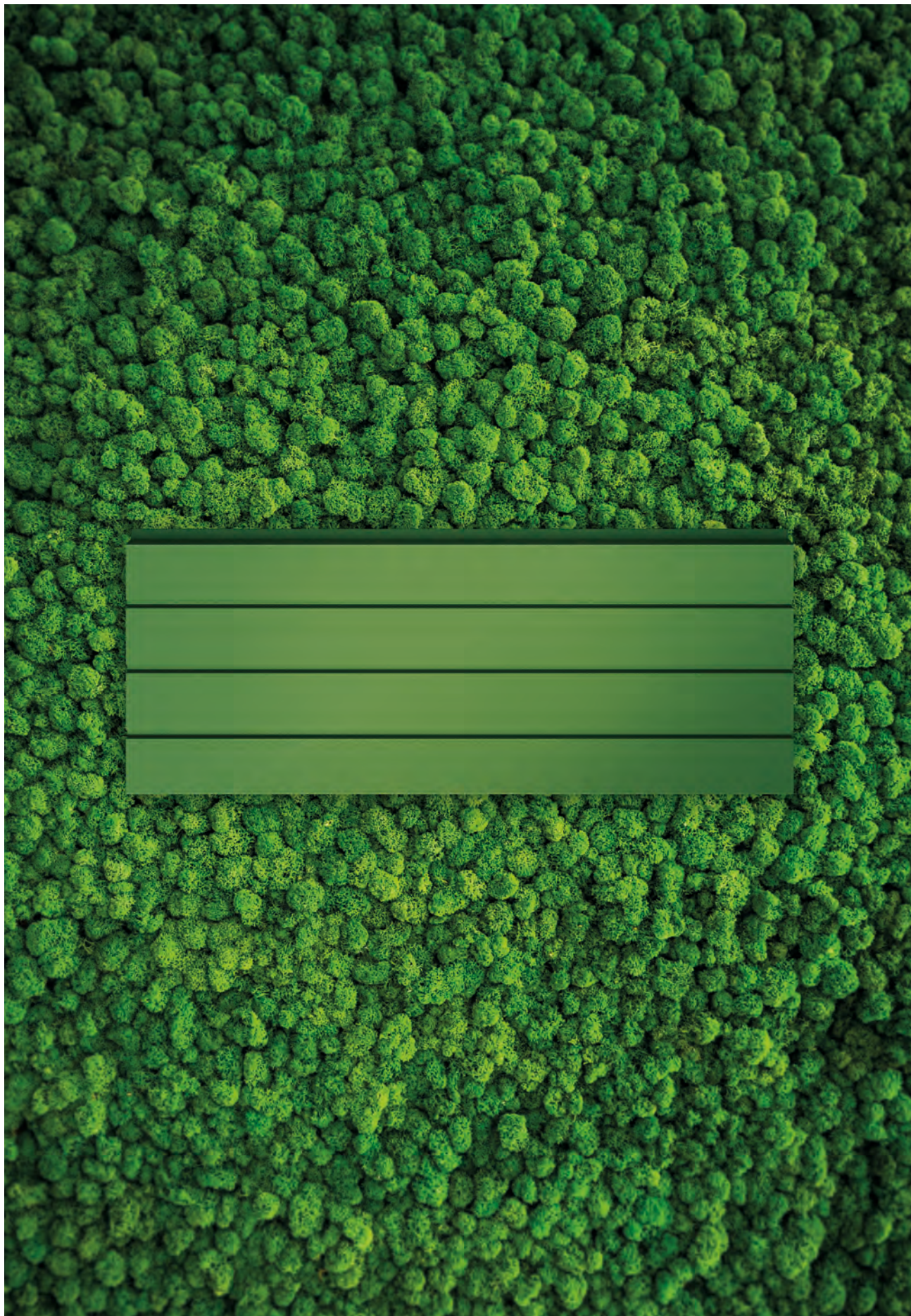

SINGLE-LAYER AND LIGHTWEIGHT

The facade of **the future.**



30-50%
SAVINGS OF RESOURCES

35–42 kg clay and fireclay are needed for 1 m² TONALITY facade ceramics, whereas conventional double-layer ceramics require 65–85 kg.

56%
LESS CO₂ EMISSIONS

compared to conventional double-layer facade tiles.

30-50%
SAVINGS OF TRANSPORT CAPACITY

A lorry with a load capacity of 24 tonnes can transport 320 m² double ceramics or 620 m² TONALITY ceramics.

48%
LESS ENERGY CONSUMPTION

of non-renewable energy sources compared to conventional double facade tiles.

30-50%
LESS PRIMARY SUBSTRUCTURE

Substantial savings of stainless steel and aluminium (e.g. for wall brackets, screws, support profiles).

ARCHITECT | TURNER, Sydney, AU
OBJECT | Col James Student Accommodation, Sydney, AU
PHOTOGRAPHY | Brett Boardman, AU
COLOR | Beige, Toscana, Cream light, TU1, GR1-4
SURFACE | smooth

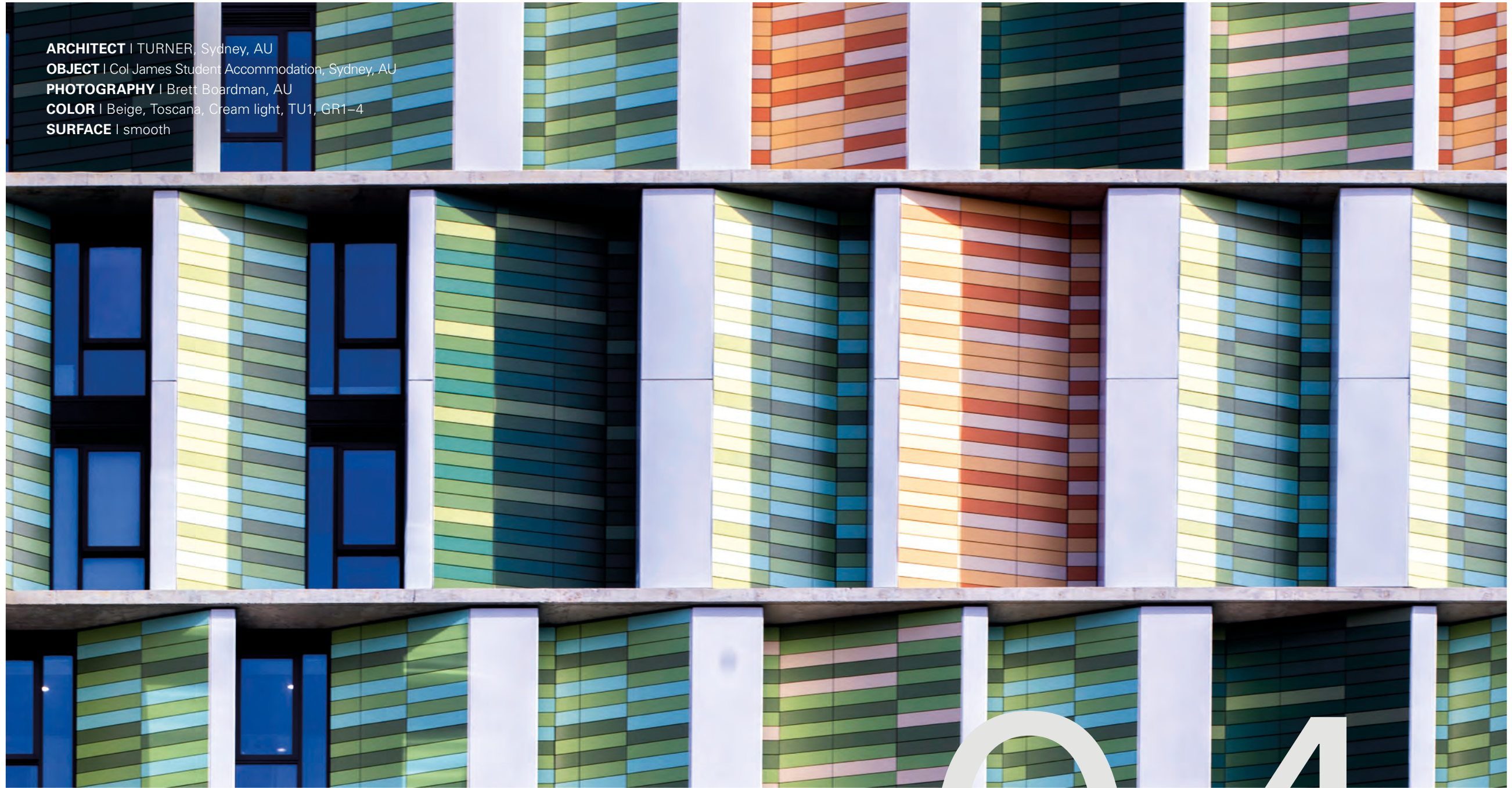

20

21

**Building
advantages**

0.4

Advantages.



01

LOW DEAD WEIGHT THANKS TO SINGLE-LAYER DESIGN

TONALITY facade elements form a single-skin system of uncompromising quality. With a visible profile of about 28 mm, TONALITY facades weigh 38-45 kg/m², being more lightweight than double-layer systems weighing 65 kg/m². This saves resources, reduces the weight considerably and simplifies processing immensely. The lightness of our products is impressive.



02

ECONOMIC ADVANTAGES

The low dead weight of our single-layer facades enables you to save valuable resources and energy from transport to the finished building. This is reflected in both the product weight and the necessary substructure. As a result, TONALITY facades are more economically efficient compared to other conventional systems.



03

QUICK AND EASY INSTALLATION THANKS TO BAS AND ADS

Thanks to our adaptive and base clinch rail systems, facade installation is stress-free and fast. The lightweight aluminium supporting structure does not require a hoist – handling and correct fastening are child's play. This also applies to the subsequent replacement of ceramic elements.



04

SAFETY FOR GENERATIONS

If the worst comes to the worst: Both the substructure and the facade elements withstand the roughest of conditions. As per DIN classification, TONALITY products belong to group A1 – i.e. are non-flammable. Even an earthquake cannot harm the system.



05

PERMANENT GRAFFITI PROTECTION

In terms of characteristics, our TONALITY facade elements have a lot to offer. They are impact- and scratch-proof, UV- and frost-resistant and resistant to graffiti, weather and thermal influences. In other words: Our facade elements rise to every challenge – without losing either shape or colour.



06

LIMITLESS VARIETY OF APPLICATIONS

From top to bottom, from left to right – as you choose: The flexible TONALITY systems can be installed in any direction. They can be used as external facade on new and refurbished buildings, as internal wall facade, as ceiling cladding, around corners, as concave or convex curves, as privacy and sun protection and even for roofs.



07

INDIVIDUALITY IN COLOUR AND SHAPE FOR YOUR DESIGN

TONALITY offers facade elements in various colours and designs, right from the basic product line. However, there are no limits to your individual preferences: Customer requests can easily be realized according to requirements.



08

INVISIBLE AND THEFT-PROOF FASTENING

The TONALITY facade element system impresses not only with easy handling, but also with fastening points that are completely invisible after installation. In addition, the joint widths are freely selectable within a range of 2 to 8 mm.



Advantages of the rear-ventilated ceramic facade.



PRINCIPLE OF THE REAR-VENTILATED RAINSCREEN FACADE

The rear-ventilated rainscreen facade design is a highly effective system due to the physical separation of insulation and weather protection functions. Due to the space between the facade cladding and the insulation, air can circulate behind the facade cladding and remove any moisture. In terms of cost-effectiveness, ecology and durability, the rear-ventilated rainscreen facade is gaining in importance as a superior system in new construction and refurbishment. This system can be used for all building types and heights. The rear-ventilated rainscreen facade system helps reduce energy costs and fully complies with the requirements for energy-saving facades. When using adequate insulation thicknesses, the rear-ventilated rainscreen facade can achieve low-energy and passive house standards.

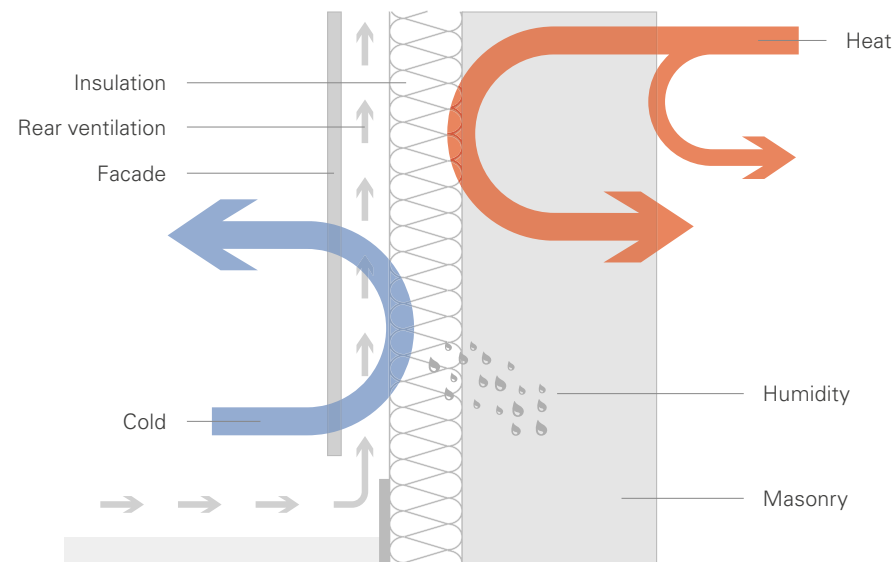

▲ Rear-ventilated rainscreen facade system: By structurally separating thermal insulation and weather protection, rear-ventilated rainscreen facades provide technical and economic security and a high degree of creative freedom.

Two systems for all installation requirements.

THE FASTENING SYSTEM

The TONALITY facade system consists of ceramic facade elements that are profiled on the back and interlock with vertical aluminium profiles. The vertical joints between the ceramic elements are backed by aluminium joint profiles. TONALITY facade elements can be used in indoor and outdoor areas for every building type and height. They are also suitable for overhead installation (ceiling cladding). The popular „portrait installation“ (vertical positioning of the ceramic elements) is possible as well. TONALITY facade elements have the technical approvals Z-10.3-796 for elements with a thickness of 22 mm and Z-10.3-798 for elements with a thickness of 26 mm. The maximum spans for the facade elements in relation to the wind load can be obtained from the specific national technical approvals.

ADS | ADAPTIVE SYSTEM

Horizontal primary substructure – high flexibility for variable joint design

- Varied design options thanks to open/closed joints, in various colours and widths
- Optimum adjustment to structural requirements due to variable depths of the support profile

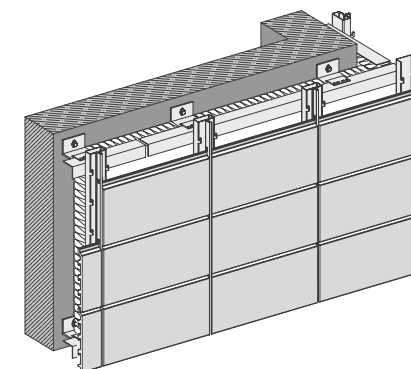

BAS | BASE CLINCH RAIL SYSTEM

Vertical primary substructure – particularly time-saving installation for highest efficiency

- Installation height from 26 mm – a plus point during facade refurbishment work
- Joint profiles and support profiles in a single element ensure fast and easy installation
- Joint profile and support profile are connected using high-tech RIVCLINCH technology

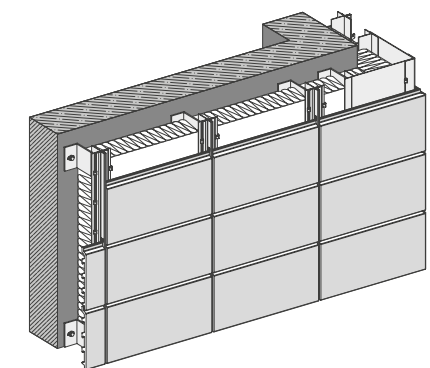

ARCHITECT | Berger+Parkkinen Architekten, Vienna, AT
OBJECT | Paracelcus Bad Kurhaus, Salzburg, AT
PHOTOGRAPHY | Christian Richters
COLOR | White matt
SURFACE | smooth



26

27

**Building
tailored solutions**

0.5

INSPIRATION | Close up, Desert, Dasht-e Kavir, Iran



FORM FOLLOWS NATURE

Nature in its most
beautiful form.



COLOR | CR1
SURFACE | Ondo

Every facade is like a tailor-made suit.

CREATIVE DIVERSITY WITHOUT BOUNDS

Your project is unique – and the TONALITY ceramic facade readily conforms. Thanks to modern manufacturing processes and seamless logistics, we are able to react quickly and precisely to your requirements. If you require colours, surface finishes or textures outside the standard range, these will be produced individually for your project. This way, facades can be planned and implemented exactly according to your specifications, just like a tailor-made suit – without any compromises.

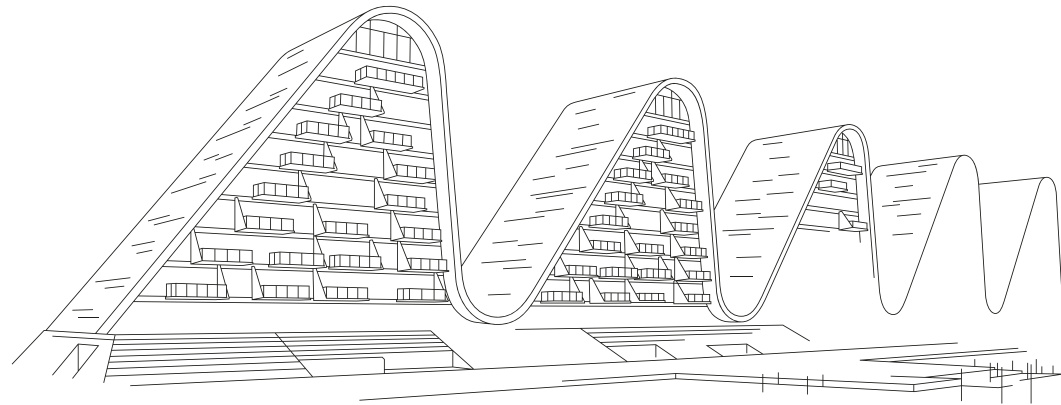

▲ The Wave, Vejle, DK

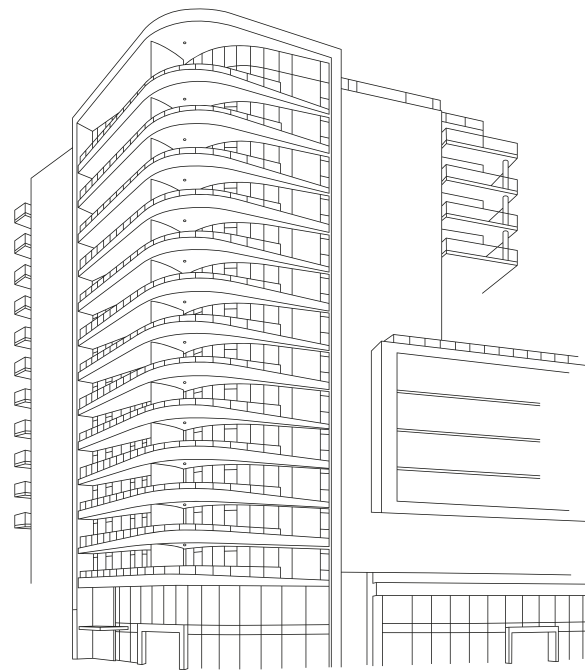

▲ Viewstar, Richmond, BC, CAN

▼ CUSTOMISED DESIGNS

TONALITY ceramic facades can be produced with millimetre accuracy in dimensions from 300 x 150 mm to 1,600 x 400 mm. And in all variants in between. In combination with the varied standard surface finishes such as smooth, grooved or with pilaster strips, there are even more possibilities per square metre.



INSPIRATION | Close up, Canyon, Arizona, USA

FORM FOLLOWS NATURE

Nature in its
strongest form.

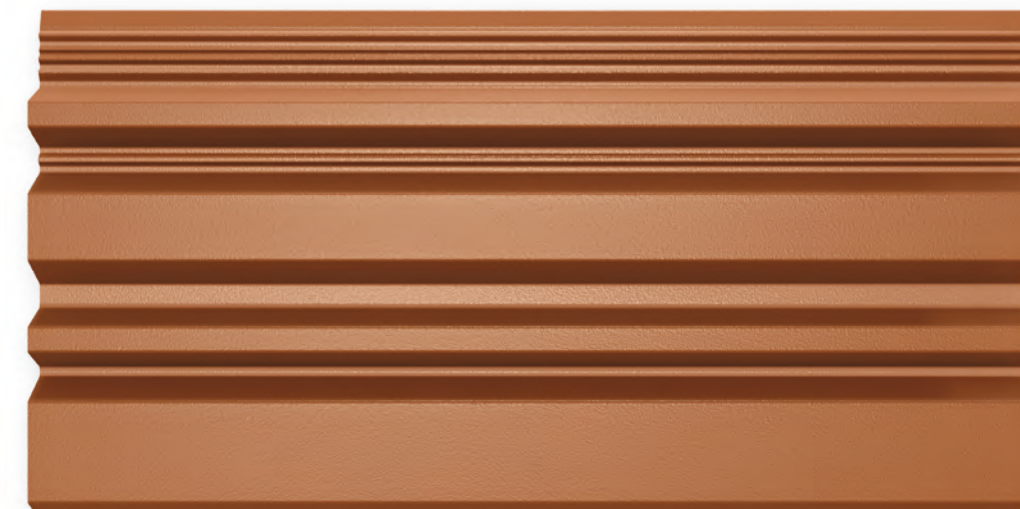

COLOR | Toscana
SURFACE | Montano

Individuality on the facade.

SURFACE FINISH VARIETY

On the surface, more than just a facade. In addition to the wide range of colours and designs, we are experts for surface finish design. And thanks to the TONALITY sinter firing process, the ceramic elements receive an even, smooth and dense surface. Choose from a variety of standard surface finishes or discuss your specific design with us. Whether a standard or a special solution, everything at TONALITY has structure.

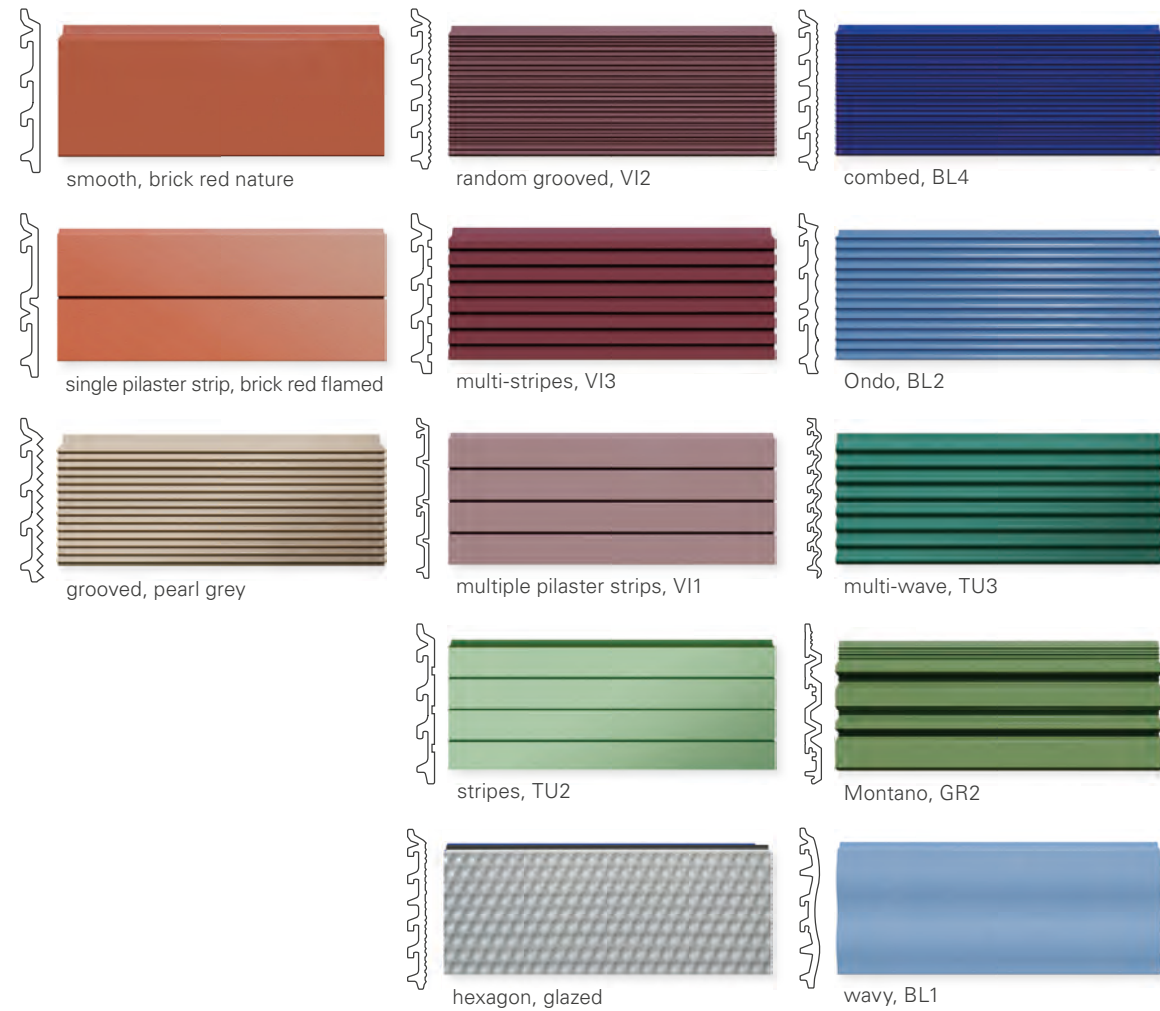

DESIGN COLLECTION

When unlimited creativity is reflected in design, something unique is created. Because it is often the impressions and colours that are to be preserved for eternity while also reflecting the planner's ideas. We bring your inspiration to life and give the facade the design for your project to be.

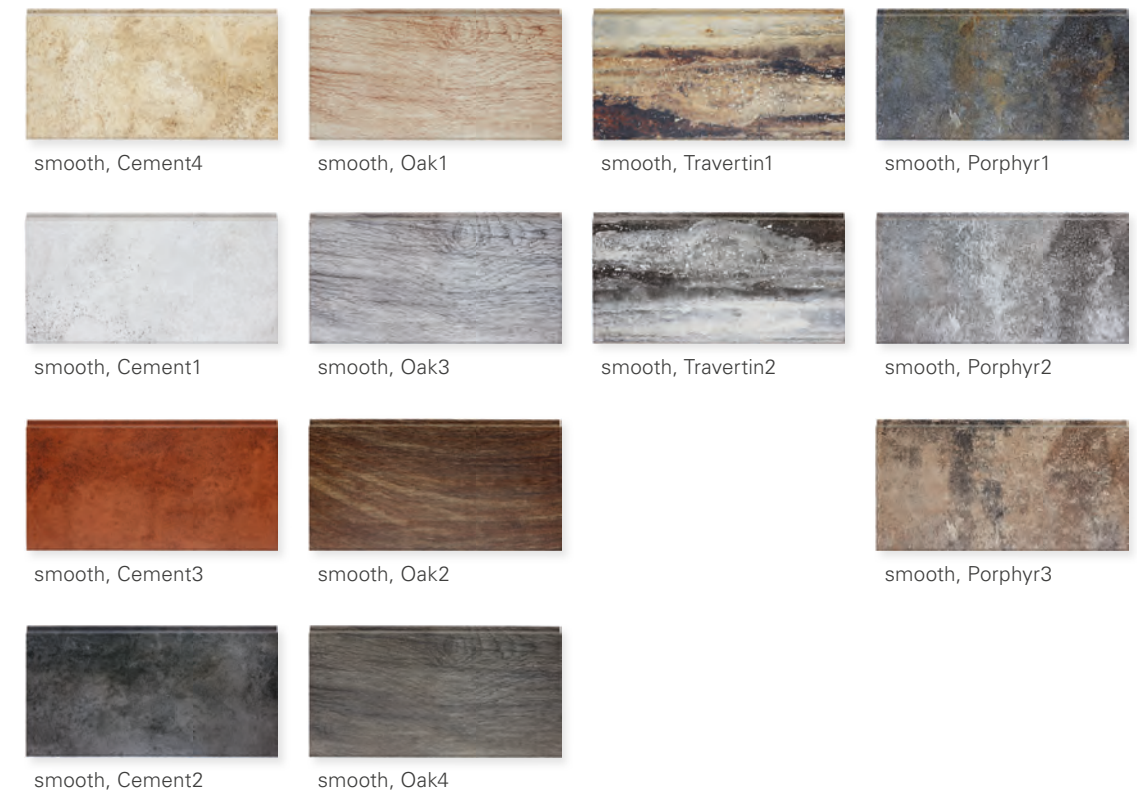

NATURE COLLECTION & COLOUR COLLECTION

Discover further colour options in our colour brochure „Inspired by nature“. www.tonality.de

Feel free to contact us for your individual facade solution on: **+49 6435 90999-0**

FORM FOLLOWS NATURE
**Nature in its
purest form.**

INSPIRATION | Close up, Wave, Hawaii



COLOR | Special colour Ocean
SURFACE | wavy

Natural privacy and sun protection.

The most natural way to integrate privacy and sun protection into a facade. No matter whether you are using Lamella, Baguette or Square elements: The ceramic TONALITY privacy and sun protection elements ideally complement the facade tile range and blend harmoniously into the overall facade design as a design element combined with metal, ceramics, glass or plaster. They can be installed either horizontally or vertically, providing both discretion and a pleasant indoor climate in the building through active sun protection.

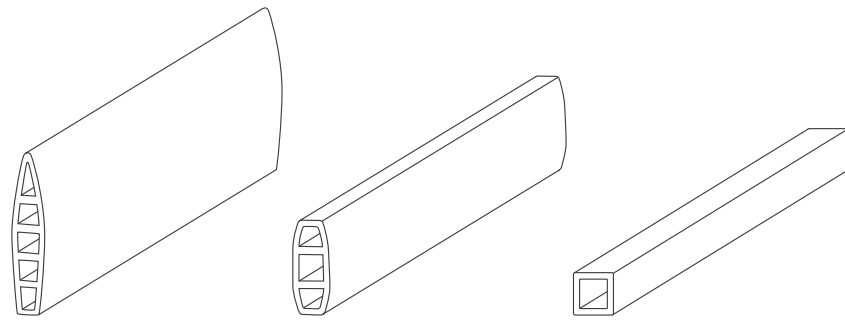

Lamella 260

Baguette 150

Square 40 / 50 / 70

The TONALITY products Lamella, Baguette and Square are available in all colours.



ARCHITECT | Cobe, Copenhagen, DK

OBJECT | Forfatterhuset Kindergarten, Copenhagen, DK

PHOTOGRAPHY | Adam Mørk, Copenhagen, DK

COLOR | 4 special colours in Brick red (natural)

SURFACE | smooth



COLOR | GR4
SURFACE | Random grooved

Inspired by nature.

TONALITY products are remarkably diverse: Choose from more than 50 immediately available colours and designs for your project. The spectrum ranges from subtle to eye-catching and is modelled on breathtaking examples out of nature – permanently colourfast and UV-resistant, of course.

And if you are looking for customised products, we will be happy to offer you individual solutions.

Discover our colour collections on our website.
Here you can also order our colour brochure.
www.tonality.de

- ▼ The undulating ceiling above the bathing area of the Paracelsus Bad has a unique appeal. It consists of hundreds of TONALITY ceramic elements, which were developed and customised especially for this new building and cover an area of about 980 square metres.

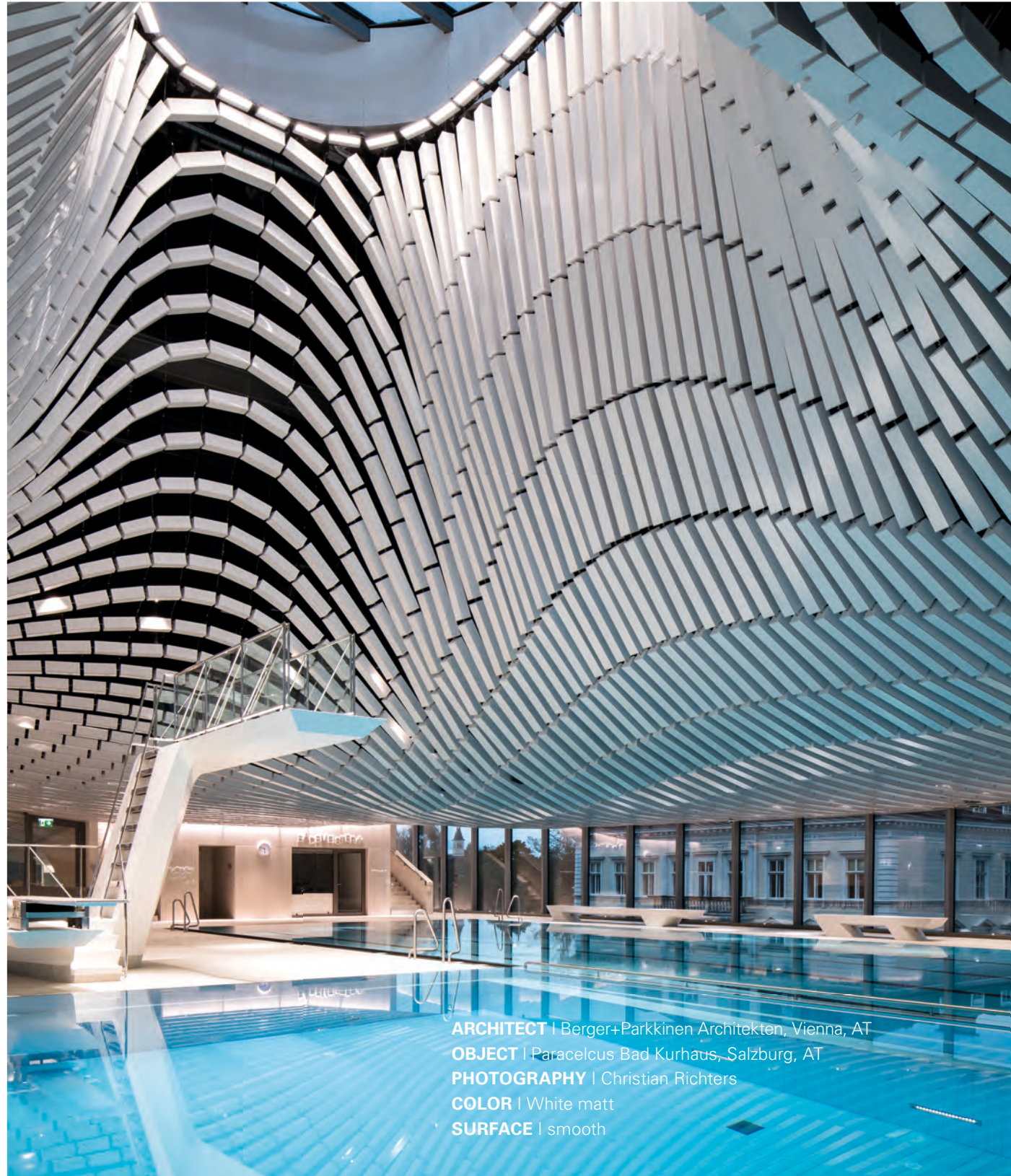

ARCHITECT | Berger+Parkkinen Architekten, Vienna, AT
OBJECT | Paracelsus Bad Kurhaus, Salzburg, AT
PHOTOGRAPHY | Christian Richters
COLOR | White matt
SURFACE | smooth

Custom-made architecture.

The unlimited application possibilities of TONALITY ceramics combine architectural ideas with extraordinary design in many respects. Building structures can be clad completely either from top to bottom or from the outside to the inside. Special ceiling designs, elegant curves or individual installation options do not represent a challenge with regard to the variety of implementation possibilities. Thanks to the one-of-a-kind product quality, TONALITY ceramic facades are impact- and scratch-proof and resistant to moss formation, salt and any influences from air. The uniquely designed wall elements, which are also suited to capture works of art, also benefit from the lifelong protective layer that makes the facade immune to graffiti or vandalism.





COLOR | Design Collection, Porphyry 1
SURFACE | smooth

Natural design.

Our proof that a ceramic element does not have to look like a ceramic element: The TONALITY design collection brings the “wow!” to facade construction – featuring modern designs in fascinating colours. Protected throughout by surfaces hardened using the MCS process. Inspired by nature.

Discover the design lines Oak, Travertin, Cement and Porphyry in exciting colour schemes. UV-resistant, extremely robust and in the usual high TONALITY quality.

Discover our colour collections on our website.
Here you can also order our colour brochure.
www.tonality.de

ARCHITECT | Jackson Teece, AU
OBJECT | St. James Chapel, Castle Hill, Sydney, AU
PHOTOGRAPHY | Michael Nicholson
COLOR | Flint grey
SURFACE | smooth



Building references

0.6



ARCHITECT | Henning Larsen, Copenhagen, DK
OBJECT | The Wave Apartments, Vejle, DK
PHOTOGRAPHY | Jacob Due, DK
COLOR | White glossy
SURFACE | smooth



- ▲ Even before the building was completed, „The Wave“ received renowned architectural prizes, among them the 2012 LEAF Award (category „Multiple Occupancy“).

A building that is making waves.

„The Wave“ is an exclusive apartment complex whose wave shape reflects both the hilly Jutland landscape and the seafaring tradition of the Danish town of Vejle. Five building elements, each with nine floors, boast unique apartments with phenomenal views. The innovative roof and facade construction, implemented with TONALITY, blends perfectly into the landscape and impresses with its harmonious design. This did not go unnoticed for long among experts: „The Wave“ is considered to be a reference for timeless Danish design.



ARCHITECT | Jaspers-Eyers Architects, BE
OBJECT | Vesalius Residential Complex, Leuven, BE
PHOTOGRAPHY | Marc Detiffe, BE
COLOR | Cream light, Pearl grey, Flint grey
SURFACE | smooth

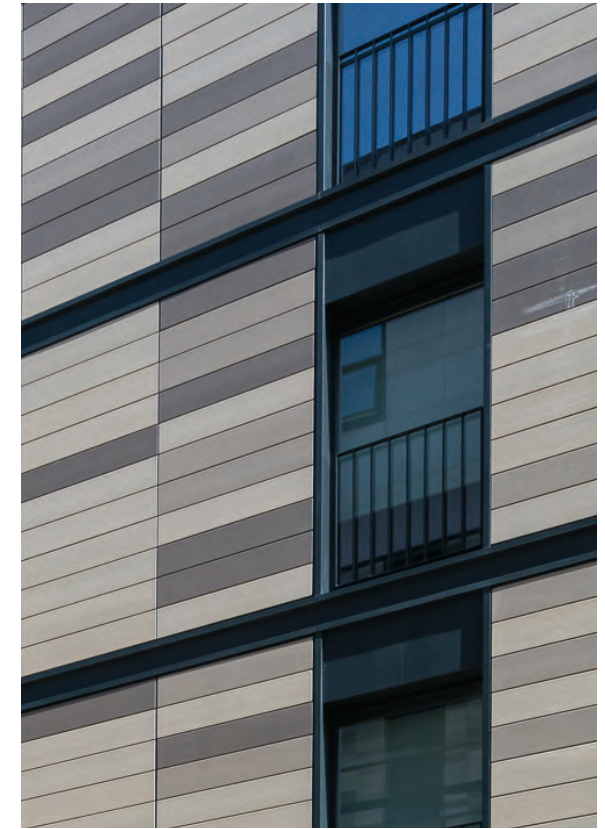

- ▲ By integrating existing listed buildings, the whole project became an interplay between new and refurbished buildings, where the contemporary character embraces historical heritage.

Integration into the existing architecture.

The „Vesalius” residential complex breathes new life into the old town quarter in Leuven, Belgium. Fired from natural Westerwald clay, the sleek ceramic facade provides more than just aesthetic value. As a colourful and distinctive envelope, the durable, maintenance-free and fire-resistant facade elements ensure lasting protection and safety without any adverse environmental effects. And with their playful earthy-sandy shades, they bring a natural lightness to the urban space.



ARCHITECT | WZMH Architects, Toronto, CA
OBJECT | Office Data Centre, Toronto, CA
PHOTOGRAPHY | Engineered Assemblies Inc., CA
COLOR | Toscana
SURFACE | smooth



- ▲ Fascinating from up close, impressively striking from a distance: The light effects of the interplay between baguette facade and ceramic elements.



Big data on the facade.

Architecture thrives on the unusual combination of familiar materials, shapes and colours. As is the case with the „Data Centre“ in Toronto. What at first appears to be an unusual mix of TONALITY facade elements and Baguette tiles reveals itself on closer inspection to be a homage to the early computer punched card technology, a precursor of today's barcodes. This makes it one of the most innovative buildings in Canada far beyond the city limits. The combination of our facade ceramics and the architect's idea resulted in a unique synthesis.



ARCHITECT | CZWG Architects, London, UK
OBJECT | Maggie's Centre, Nottingham, UK
PHOTOGRAPHY | Tiles International Ltd, Glasgow, UK
COLOR | TU2
SURFACE | smooth



Facades can also get around curves.

Out of the 100 million colour shades the human eye is capable of distinguishing, it perceives green most intensely. That is why TONALITY attaches great importance to brilliant colours, shades and surfaces. Especially when they are individually made to customer specifications, like at „Maggie’s Centre“ in Nottingham. Because in addition to the wide range of standard colours, structures and surface finishes, we are experts in special surface and colour designs. Simply because we can.

Impressively vibrant shades of green meet exclusive shapes: „Maggie’s Centre“ in Nottingham and the TONALITY products complement each other perfectly. ▶

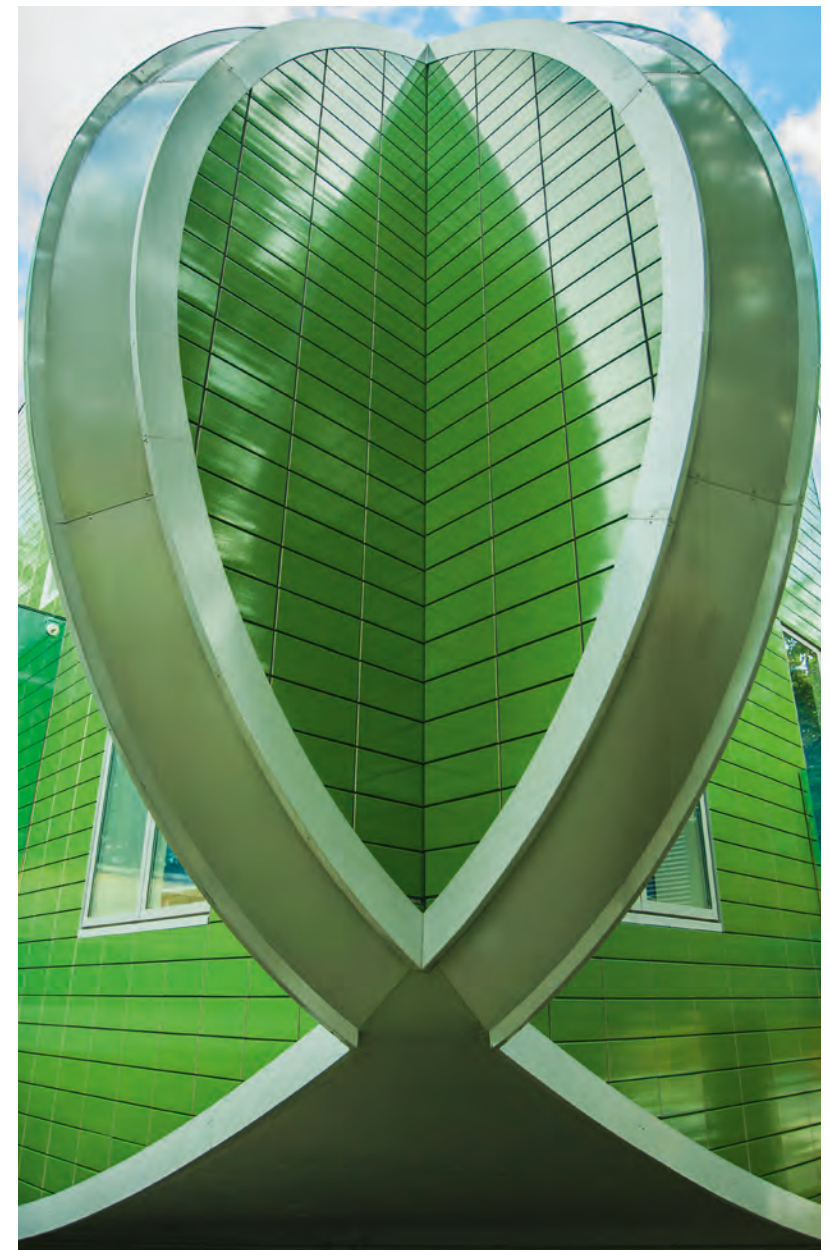



ARCHITECT | Wollenweberarchitektur, Düsseldorf, DE
OBJECT | Robert-Junck-Gesamtschule, Krefeld, DE
PHOTOGRAPHY | Sven Tornow, Cologne, DE
COLOR | Pearl grey
SURFACE | smooth



▲ The new building of the Comprehensive School Krefeld was designed by Wollenweberarchitektur. The TONALITY facade in pearl grey perfectly complements the modern design.



Striking accentuation.

Strong look with strong features: The extension of the Robert Junck Comprehensive School in Krefeld-Hüls was implemented using TONALITY ceramic elements in a rear-ventilated facade. The scratch- and impact-proof elements impress with fascinating geometries and dynamically structured surfaces. The UV-resistant facade in pearl grey creates exciting light effects in any weather. Thanks to our innovative facade systems, the square detached building meets all modern energy efficiency requirements.

ARCHITECT | dd Planquadrat Architekten, Duisburg, DE
OBJECT | Kompetenz Center der Sparkasse, Duisburg, DE
PHOTOGRAPHY | Sven Tornow, Cologne, DE
COLOR | Cream, Anthracite
SURFACE | smooth





From roof to base – a stylish investment.

The new Sparkasse Competence Centre in Duisburg's Hamborn district captivates with a clean and elegant design. The TONALITY facades in cream and anthracite blend perfectly into the cityscape, creating interesting contrasts to the building's generous window fronts.

Another striking element is the gable roof, which was also clad with TONALITY ceramic elements. The elements offer optimum protection against weather influences as well as outstanding insulation properties and can be installed in various patterns. Of course, clients again benefit from UV-resistance, colourfastness and durability.

The sandstone-coloured TONALITY ceramic facade perfectly integrates the new three-storey building into the Hamborn city centre. The gable roof consisting of ceramic elements stands out from the urban roof landscape.



ARCHITECT | Spacelab Architects, Copenhagen, DK
OBJECT | Dahl Advokatskandlei, Viborg, DK
COLOR | Anthracite
SURFACE | smooth





- ▲ The anthracite-coloured building presents itself as a gracious eye-catcher amidst the Nordic surroundings. It combines timeless elegance and straightforward architecture to create a unique masterpiece.



Homogeneous envelope.

The corporate headquarters of one of Denmark's largest law firms in Viborg presents itself with simple elegance. Designed by Spacefab, the building boasts a sculptural body with a bright atrium as its centrepiece. Its facade conveys the architecture's purist approach: Anthracite-coloured ceramic panels wrap around the building like a homogeneous envelope and – in combination with the slender window openings and the vertically installed ceramic elements – ensure a uniform overall appearance. With its focus on light, openness, functionality and flexibility, the building fulfils the essential requirements of a modern workplace.



ARCHITECT | Architekt Huber ZT, Lustenau, AT
OBJECT | Kinderhaus Pertinsel, Fussach, AT
PHOTOGRAPHY | Günter Laznia
COLOR | Cream, Pearl grey, 1 special colour
SURFACE | smooth



- ◀ Apart from the visual accentuation through wood and ceramic elements, the building also impresses in terms of economic efficiency and sustainability due to the high quality of the materials used.

Natural harmony.

The Pertinsel childcare centre in Fußach, Austria, blends in with its surroundings and skilfully incorporates them into its architecture. The building's interior offers spacious and light-flooded rooms with a variety of designs. This is contrasted by the understated building envelope. A curtain wall system made of elongated ceramic elements in three light sand tones comes into play here. This completely encloses the head-end structure of the building and, thanks to the natural colouring, harmonises with the facade's wooden cladding. Apart from setting visual accents, the building also impresses in terms of economic efficiency and sustainability due to the high quality of the materials used.

ARCHITECT | Cobe, Copenhagen, DK
OBJECT | Forfatterhuset Kindergarten, Copenhagen, DK
PHOTOGRAPHY | Adam Mørk, Copenhagen, DK
COLOR | 4 special colours in Brick red (natural)
SURFACE | smooth



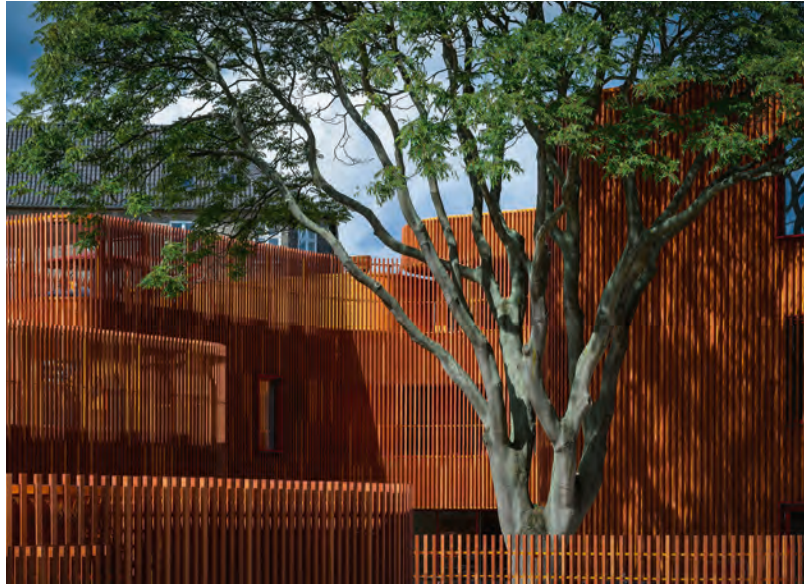

◀ The most natural way to integrate privacy and sun protection into a facade.

To see and not be seen.

No matter whether you are using Lamella, Baguette or Square elements: They all blend harmoniously into the overall facade design as a solitary design element combined with metal, ceramics, glass or plaster, providing both privacy and a pleasant indoor climate in the building through active sun protection. Available in numerous dimensions and colours, these elements make it possible to realise impressive architectural design concepts both on external facades and inside buildings. Whether installed as privacy or sun protection, they are real eye-catchers either way.



ARCHITECT | HAL Architects, Brisbane, AU
OBJECT | Toowong Train Station, Queensland, AU
COLOR | White matt, Dark grey, Bright grey
SURFACE | smooth

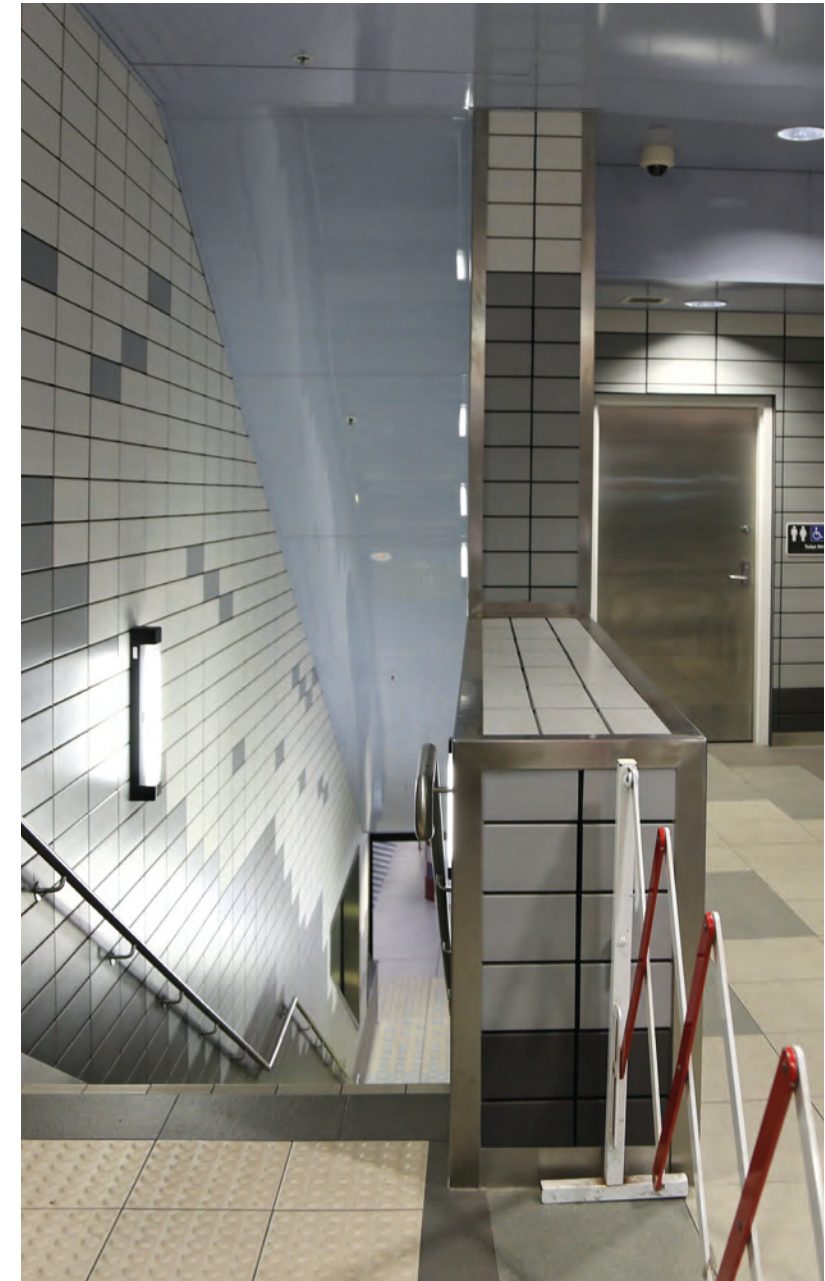
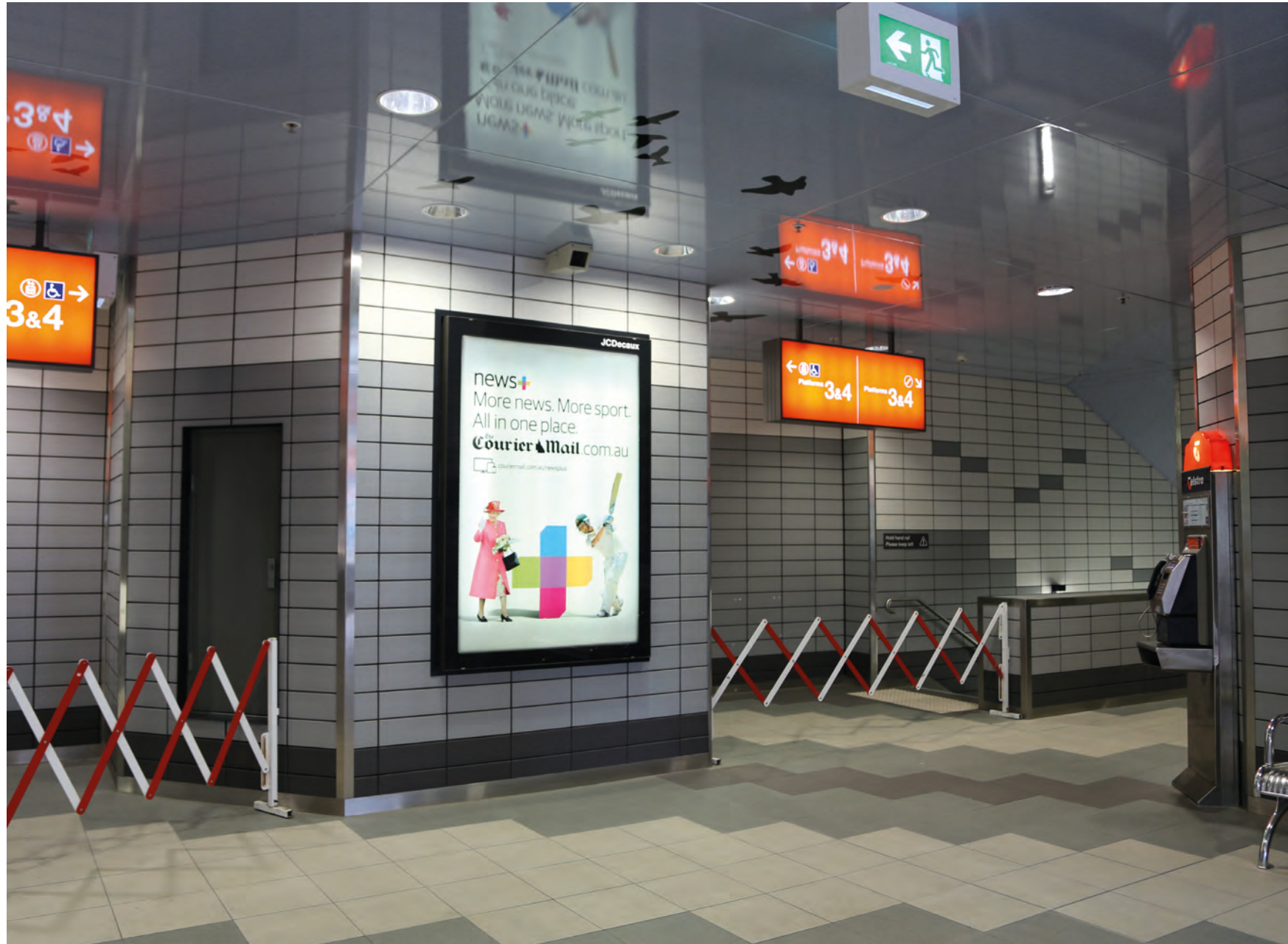

▲ Public institutions and buildings are constantly exposed to all kinds of influences. This challenging environment requires superior quality.

Stylish and fortified in Down Under.

In railway stations, such as the Toowong Train Station in Australia, TONALITY ceramic facades can fully demonstrate their much-appreciated qualities. Bold colours and flexible installation options ensure an individual, stylish and clean look. The glazed surface provides lasting, reliable protection against soiling and graffiti. A dream come true for public buildings and their managers – all over the world.

ARCHITECT | TURNER, Sydney, AU
OBJECT | Sanctuary at Wentworth Point, Sydney, AU
PHOTOGRAPHY | Tom Ferguson Photography
COLOR | Bright red, Anthracite, Kimura beige
SURFACE | smooth





◀ The four buildings wrapped in ceramic facades match the natural earth tones of the surrounding area. The soft curves of the facade reflect the wide meander of the adjacent river.

Urban lightness.

Surrounded by the stunning landscape of Australia's Newington Nature Reserve, the sprawling residential project Sanctuary by Sekisui House presents a harmonious blend of Japanese design principles and Australian identity. Built on the banks of the Parramatta River, the urban structure covers all the needs of daily life, combining multi-storey apartment buildings with retail and office space. An exciting interplay of ceramic panels in natural earth tones and anthracite-coloured steel reinforced concrete elements characterises the exterior design of the multifunctional buildings. Vertical clay louvres and floor-to-ceiling glass windows lend the facades their light appearance.

ARCHITECT | PLH Arkitekter A/S, Copenhagen, DK
OBJECT | Velliv, Ballerup, DK
PHOTOGRAPHY | Thorbjørn Hansen, Copenhagen, DK
COLOR | White glossy
SURFACE | Square





White – in its purest form.

The timelessly elegant office building in Denmark stands out with its distinctive shape and unpretentious interior design. In keeping with the motto „hard shell, soft core“, the high-contrast object blends perfectly into Ballerup’s cityscape. The design radiates openness and simplicity, supporting the employees’ need for exchange of knowledge and individuality.

The baguettes in glossy white not only give the building a unique appearance, but also an incomparable robustness. TONALITY ceramic facades are impact- and scratch-proof, UV- and frost-resistant and fortified against graffiti, weather and thermal influences, making them perfect for the rough conditions a facade needs to withstand every day. ▲

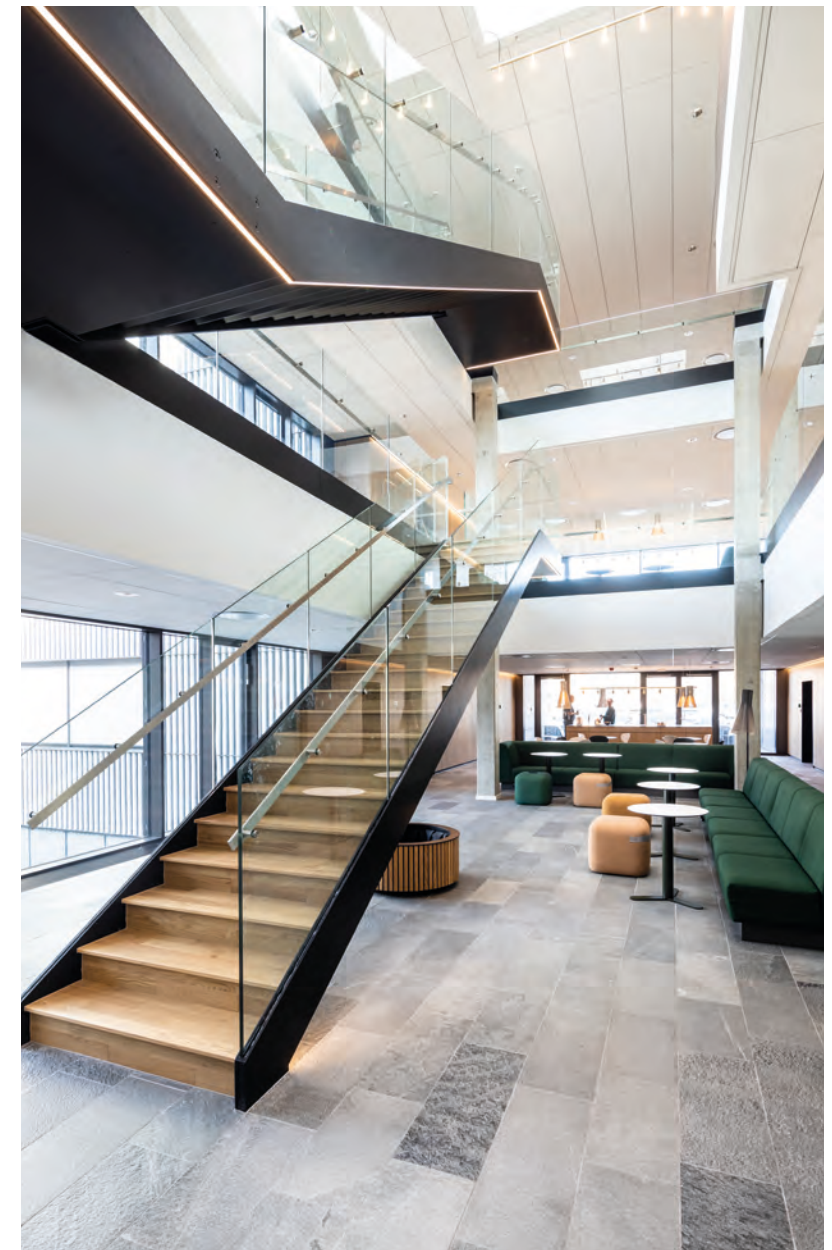

Albania | Australia | Austria | Belgium | Bosnia and Herzegovina | Bulgaria | Canada | Croatia | Czech Republic | Denmark | Estonia
Finland | France | Germany | Greece | Hungary | Iran | Ireland | Italy | Kazakhstan | Kosovo | Latvia | Lithuania | Luxembourg | Macedonia
Montenegro | Netherlands | New Zealand | Norway | Poland | Russian Federation | Serbia | Slovakia | Slovenia | South Korea | Spain
Sweden | Switzerland | Turkey | United Kingdom | USA | Vietnam



A company of the
LEIPFINGER-BADER Group

TONALITY® GmbH

In der Mark 100
D-56414 Weroth

Tel. +49 6435 90999-0
info@tonality.de



www.tonality.de

