



ALLFACE
Smart Fixing Systems

Product List 2023



Brackets	3
Aluminium brackets	3
F1.brackets	3
F2.brackets	31
F3.brackets	43
F4.brackets	48
Y-brackets	58
Profiles	62
L-profiles	62
T-profiles	66
Z-profiles	70
Omega profiles	75
Flat profiles	80
Joint profiles	82
Special profiles	85
System parts	88
F1.40 C-hanger system	88
F1.41 C-hanger system	100
F1.44 C-hanger system	104
F1.50/F2.50 Cassette system	108
F1.59/F1.59i/F2.59/F2.59i Cassette system	110
SZ20 Cassette system	114
F1.23/F1.24	116
F1.29 Terracotta system	119
F3.33	122
TS 300	125
ME01	127
IN.40	130
Accessories	132
Insulator pads	132
Insulator pad F1	132
Insulator pad F2	134
Insulator pad F3	136
Insulator pad F4	138
Profiles for clip system	140
Aluminium- and stainless steel clips	143
Aluminium clips	143
Stainless steel clips	147
Primary fixings	150
Screws	156
Facade screws	160
Rivets	163
Accessories	167



ALLFACE
Smart Fixing Systems

F1.brackets (D11)

Product List 2023. Prices in EUR exkl. 20% VAT subject to change without notice.

Allface Befestigungstechnologie GmbH
www.allface.com

3/176



	PARTNUMBER	DESCRIPTION	UNIT
	F1.035D11	bracket F1, material EN AW 6060.T66, 1 fixing hole 22/11mm, height 90mm, depth 35mm, packing unit: 200 pcs./box	Pcs.
	F1.050D11	bracket F1, material EN AW 6060.T66, 1 fixing hole 22/11mm, height 90mm, depth 50mm, packing unit: 200 pcs./box	Pcs.
	F1.080D11	bracket F1, material EN AW 6060.T66, 1 fixing hole 22/11mm, height 90mm, depth 80mm, packing unit: 120 pcs./box	Pcs.
	F1.100D11	bracket F1, material EN AW 6060.T66, 1 fixing hole 22/11mm, height 90mm, depth 100mm, packing unit: 100 pcs./box	Pcs.
	F1.115D11	bracket F1, material EN AW 6060.T66, 1 fixing hole 22/11mm, height 90mm, depth 115mm, packing unit: 100 pcs./box	Pcs.
	F1.135D11	bracket F1, material EN AW 6060.T66, 1 fixing hole 22/11mm, height 90mm, depth 135mm, packing unit: 80 pcs./box	Pcs.
	F1.150D11	bracket F1, material EN AW 6060.T66, 1 fixing hole 22/11mm, height 90mm, depth 150mm, packing unit: 80 pcs./box	Pcs.

Product List 2023. Prices in EUR exkl. 20% VAT subject to change without notice.



	PARTNUMBER	DESCRIPTION	UNIT
	F1.170D11	bracket F1, material EN AW 6060.T66, 1 fixing hole 22/11mm, height 90mm, depth 170mm, packing unit: 80 pcs./box	Pcs.
	F1.185D11	bracket F1, material EN AW 6060.T66, 1 fixing hole 22/11mm, height 90mm, depth 185mm, packing unit: 80 pcs./box	Pcs.
	F1.200D11	bracket F1, material EN AW 6060.T66, 1 fixing hole 22/11mm, height 90mm, depth 200mm, packing unit: 60 pcs./box	Pcs.
	F1.220D11	bracket F1, material EN AW 6060.T66, 1 fixing hole 22/11mm, height 90mm, depth 220mm, packing unit: 60 pcs./box	Pcs.
	F1.235D11	bracket F1, material EN AW 6060.T66, 1 fixing hole 22/11mm, height 90mm, depth 235mm, packing unit: 50 pcs./box	Pcs.
	F1.255D11	bracket F1, material EN AW 6060.T66, 1 fixing hole 22/11mm, height 90mm, depth 255mm, packing unit: 50 pcs./box	Pcs.
	F1.285D11	bracket F1, material EN AW 6060.T66, 1 fixing hole 22/11mm, height 90mm, depth 285mm, packing unit: 50 pcs./box	Pcs.

Product List 2023. Prices in EUR exkl. 20% VAT subject to change without notice.

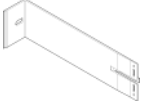

	PARTNUMBER	DESCRIPTION	UNIT
	F1.320D11	bracket F1, material EN AW 6060.T66, 1 fixing hole 22/11mm, height 90mm, depth 320mm, packing unit: 50 pcs./box	Pcs.



ALLFACE
Smart Fixing Systems

F1.brackets (D6,5)

Product List 2023. Prices in EUR exkl. 20% VAT subject to change without notice.

Allface Befestigungstechnologie GmbH
www.allface.com

7/176



	PARTNUMBER	DESCRIPTION	UNIT
	F1.035D6,5	bracket F1, material EN AW 6060.T66, 1 fixing hole 22/6,5mm, height 90mm, depth 35mm, packing unit: 200 pcs./box	Pcs.
	F1.050D6,5	bracket F1, material EN AW 6060.T66, 1 fixing hole 22/6,5mm, height 90mm, depth 50mm, packing unit: 200 pcs./box	Pcs.
	F1.080D6,5	bracket F1, material EN AW 6060.T66, 1 fixing hole 22/6,5mm, height 90mm, depth 80mm, packing unit: 120 pcs./box	Pcs.
	F1.100D6,5	bracket F1, material EN AW 6060.T66, 1 fixing hole 22/6,5mm, height 90mm, depth 100mm, packing unit: 100 pcs./box	Pcs.
	F1.115D6,5	bracket F1, material EN AW 6060.T66, 1 fixing hole 22/6,5mm, height 90mm, depth 115mm, packing unit: 100 pcs./box	Pcs.
	F1.135D6,5	bracket F1, material EN AW 6060.T66, 1 fixing hole 22/6,5mm, height 90mm, depth 135mm, packing unit: 80 pcs./box	Pcs.
	F1.150D6,5	bracket F1, material EN AW 6060.T66, 1 fixing hole 22/6,5mm, height 90mm, depth 150mm, packing unit: 80 pcs./box	Pcs.

Product List 2023. Prices in EUR exkl. 20% VAT subject to change without notice.



	PARTNUMBER	DESCRIPTION	UNIT
	F1.170D6,5	bracket F1, material EN AW 6060.T66, 1 fixing hole 22/6,5mm, height 90mm, depth 170mm, packing unit: 80 pcs./box	Pcs.
	F1.185D6,5	bracket F1, material EN AW 6060.T66, 1 fixing hole 22/6,5mm, height 90mm, depth 185mm, packing unit: 80 pcs./box	Pcs.
	F1.200D6,5	bracket F1, material EN AW 6060.T66, 1 fixing hole 22/6,5mm, height 90mm, depth 200mm, packing unit: 60 pcs./box	Pcs.
	F1.220D6,5	bracket F1, material EN AW 6060.T66, 1 fixing hole 22/6,5mm, height 90mm, depth 220mm, packing unit: 60 pcs./box	Pcs.
	F1.235D6,5	bracket F1, material EN AW 6060.T66, 1 fixing hole 22/6,5mm, height 90mm, depth 235mm, packing unit: 50 pcs./box	Pcs.
	F1.255D6,5	bracket F1, material EN AW 6060.T66, 1 fixing hole 22/6,5mm, height 90mm, depth 255mm, packing unit: 50 pcs./box	Pcs.
	F1.285D6,5	bracket F1, material EN AW 6060.T66, 1 fixing hole 22/6,5mm, height 90mm, depth 285mm, packing unit: 50 pcs./box	Pcs.

Product List 2023. Prices in EUR exkl. 20% VAT subject to change without notice.

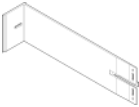

PARTNUMBER	DESCRIPTION	UNIT
	F1.320D6,5 bracket F1, material EN AW 6060.T66, 1 fixing hole 22/6,5mm, height 90mm, depth 320mm, packing unit: 50 pcs./box	Pcs.

Product List 2023. Prices in EUR exkl. 20% VAT subject to change without notice.



ALLFACE
Smart Fixing Systems

F1.brackets (D6,5X2)

Product List 2023. Prices in EUR exkl. 20% VAT subject to change without notice.

Allface Befestigungstechnologie GmbH
www.allface.com

11/176



	PARTNUMBER	DESCRIPTION	UNIT
	F1.035D6,5X2	bracket F1, material EN AW 6060.T66, 2 fixing holes 22/6,5mm, height 90mm, depth 35mm, packing unit: 200 pcs./box	Pcs.
	F1.050D6,5X2	bracket F1, material EN AW 6060.T66, 2 fixing holes 22/6,5mm, height 90mm, depth 50mm, packing unit: 200 pcs./box	Pcs.
	F1.080D6,5X2	bracket F1, material EN AW 6060.T66, 2 fixing holes 22/6,5mm, height 90mm, depth 80mm, packing unit: 120 pcs./box	Pcs.
	F1.100D6,5X2	bracket F1, material EN AW 6060.T66, 2 fixing holes 22/6,5mm, height 90mm, depth 100mm, packing unit: 100 pcs./box	Pcs.
	F1.115D6,5X2	bracket F1, material EN AW 6060.T66, 2 fixing holes 22/6,5mm, height 90mm, depth 115mm, packing unit: 100 pcs./box	Pcs.
	F1.135D6,5X2	bracket F1, material EN AW 6060.T66, 2 fixing holes 22/6,5mm, height 90mm, depth 135mm, packing unit: 80 pcs./box	Pcs.
	F1.150D6,5X2	bracket F1, material EN AW 6060.T66, 2 fixing holes 22/6,5mm, height 90mm, depth 150mm, packing unit: 80 pcs./box	Pcs.

Product List 2023. Prices in EUR exkl. 20% VAT subject to change without notice.



	PARTNUMBER	DESCRIPTION	UNIT
	F1.170D6,5X2	bracket F1, material EN AW 6060.T66, 2 fixing holes 22/6,5mm, height 90mm, depth 170mm, packing unit: 80 pcs./box	Pcs.
	F1.185D6,5X2	bracket F1, material EN AW 6060.T66, 2 fixing holes 22/6,5mm, height 90mm, depth 185mm, packing unit: 80 pcs./box	Pcs.
	F1.200D6,5X2	bracket F1, material EN AW 6060.T66, 2 fixing holes 22/6,5mm, height 90mm, depth 200mm, packing unit: 60 pcs./box	Pcs.
	F1.220D6,5X2	bracket F1, material EN AW 6060.T66, 2 fixing holes 22/6,5mm, height 90mm, depth 220mm, packing unit: 60 pcs./box	Pcs.
	F1.235D6,5X2	bracket F1, material EN AW 6060.T66, 2 fixing holes 22/6,5mm, height 90mm, depth 235mm, packing unit: 50 pcs./box	Pcs.
	F1.255D6,5X2	bracket F1, material EN AW 6060.T66, 2 fixing holes 22/6,5mm, height 90mm, depth 255mm, packing unit: 50 pcs./box	Pcs.
	F1.285D6,5X2	bracket F1, material EN AW 6060.T66, 2 fixing holes 22/6,5mm, height 90mm, depth 285mm, packing unit: 50 pcs./box	Pcs.

Product List 2023. Prices in EUR exkl. 20% VAT subject to change without notice.

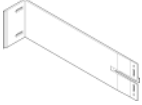

	PARTNUMBER	DESCRIPTION	UNIT
	F1.320D6,5X2	bracket F1, material EN AW 6060.T66, 2 fixing holes 22/6,5mm, height 90mm, depth 320mm, packing unit: 50 pcs./box	Pcs.

Product List 2023. Prices in EUR exkl. 20% VAT subject to change without notice.



ALLFACE
Smart Fixing Systems







F1.brackets (X3)

Product List 2023. Prices in EUR exkl. 20% VAT subject to change without notice.

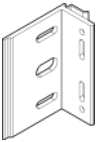
Allface Befestigungstechnologie GmbH
www.allface.com

15/176



	PARTNUMBER	DESCRIPTION	UNIT
	F1.035X3	Single Bracket F1, material EN AW 6060.T66, 3 fixing holes, 2x22/6,5mm & 1x22/11mm, H90mm, D35mm, box quantity: 200 pcs./box	Pcs.
	F1.050X3	Single Bracket F1, material EN AW 6060.T66, 3 fixing holes, 2x22/6,5mm & 1x22/11mm, H90mm, D50mm, box quantity: 200 pcs./box	Pcs.
	F1.080X3	Single Bracket F1, material EN AW 6060.T66, 3 fixing holes, 2x22/6,5mm & 1x22/11mm, H90mm, D80mm, box quantity: 120 pcs./box	Pcs.
	F1.100X3	Single Bracket F1, material EN AW 6060.T66, 3 fixing holes, 2x22/6,5mm & 1x22/11mm, H90mm, D100mm, box quantity: 100 pcs./box	Pcs.
	F1.115X3	Single Bracket F1, material EN AW 6060.T66, 3 fixing holes, 2x22/6,5mm & 1x22/11mm, H90mm, D115mm, box quantity: 100 pcs./box	Pcs.
	F1.135X3	Single Bracket F1, material EN AW 6060.T66, 3 fixing holes, 2x22/6,5mm & 1x22/11mm, H90mm, D135mm, box quantity: 80 pcs./box	Pcs.
	F1.150X3	Single Bracket F1, material EN AW 6060.T66, 3 fixing holes, 2x22/6,5mm & 1x22/11mm, H90mm, D150mm, box quantity: 80 pcs./box	Pcs.

Product List 2023. Prices in EUR exkl. 20% VAT subject to change without notice.

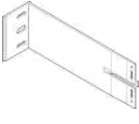

	PARTNUMBER	DESCRIPTION	UNIT
	F1.170X3	Single Bracket F1, material EN AW 6060.T66, 3 fixing holes, 2x22/6,5mm & 1x22/11mm, H90mm, D170mm, box quantity: 80 pcs./box	Pcs.
	F1.185X3	Single Bracket F1, material EN AW 6060.T66, 3 fixing holes, 2x22/6,5mm & 1x22/11mm, H90mm, D185mm, box quantity: 80 pcs./box	Pcs.
	F1.200X3	Single Bracket F1, material EN AW 6060.T66, 3 fixing holes, 2x22/6,5mm & 1x22/11mm, H90mm, D200mm, box quantity: 60 pcs./box	Pcs.
	F1.220X3	Single Bracket F1, material EN AW 6060.T66, 3 fixing holes, 2x22/6,5mm & 1x22/11mm, H90mm, D220mm, box quantity: 60 pcs./box	Pcs.
	F1.235X3	Single Bracket F1, material EN AW 6060.T66, 3 fixing holes, 2x22/6,5mm & 1x22/11mm, H90mm, D235mm, box quantity: 50pcs./box	Pcs.
	F1.255X3	Single Bracket F1, material EN AW 6060.T66, 3 fixing holes, 2x22/6,5mm & 1x22/11mm, H90mm, D255mm, box quantity: 50pcs./box	Pcs.
	F1.285X3	Single Bracket F1, material EN AW 6060.T66, 3 fixing holes, 2x22/6,5mm & 1x22/11mm, H90mm, D285mm, box quantity: 50pcs./box	Pcs.

Product List 2023. Prices in EUR exkl. 20% VAT subject to change without notice.



	PARTNUMBER	DESCRIPTION	UNIT
	F1.320X3	Single Bracket F1, material EN AW 6060.T66, 3 fixing holes, 2x22/6,5mm & 1x22/11mm, H90mm, D320mm, box quantity: 50pcs./box	Pcs.

Product List 2023. Prices in EUR exkl. 20% VAT subject to change without notice.



ALLFACE
Smart Fixing Systems



F1+brackets (D11)

Product List 2023. Prices in EUR exkl. 20% VAT subject to change without notice.

Allface Befestigungstechnologie GmbH
www.allface.com

19/176

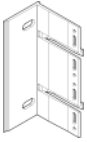
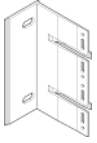
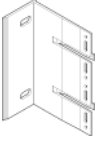
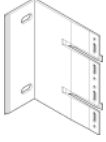
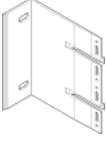

	PARTNUMBER	DESCRIPTION	UNIT
	F1+035D11	bracket F1+, material EN AW 6060.T66, 2 fixing holes 22/11mm, height 175mm, depth 35mm, packing unit: 100 pcs./box	Pcs.
	F1+050D11	bracket F1+, material EN AW 6060.T66, 2 fixing holes 22/11mm, height 175mm, depth 50mm, packing unit: 100 pcs./box	Pcs.
	F1+080D11	bracket F1+, material EN AW 6060.T66, 2 fixing holes 22/11mm, height 175mm, depth 80mm, packing unit: 60 pcs./box	Pcs.
	F1+100D11	bracket F1+, material EN AW 6060.T66, 2 fixing holes 22/11mm, height 175mm, depth 100mm, packing unit: 50 pcs./box	Pcs.
	F1+115D11	bracket F1+, material EN AW 6060.T66, 2 fixing holes 22/11mm, height 175mm, depth 115mm, packing unit: 50 pcs./box	Pcs.
	F1+135D11	bracket F1+, material EN AW 6060.T66, 2 fixing holes 22/11mm, height 175mm, depth 135mm, packing unit: 40 pcs./box	Pcs.
	F1+150D11	bracket F1+, material EN AW 6060.T66, 2 fixing holes 22/11mm, height 175mm, depth 150mm, packing unit: 40 pcs./box	Pcs.

Product List 2023. Prices in EUR exkl. 20% VAT subject to change without notice.



	PARTNUMBER	DESCRIPTION	UNIT
	F1+170D11	bracket F1+, material EN AW 6060.T66, 2 fixing holes 22/11mm, height 175mm, depth 170mm, packing unit: 40 pcs./box	Pcs.
	F1+185D11	bracket F1+, material EN AW 6060.T66, 2 fixing holes 22/11mm, height 175mm, depth 185mm, packing unit: 40 pcs./box	Pcs.
	F1+200D11	bracket F1+, material EN AW 6060.T66, 2 fixing holes 22/11mm, height 175mm, depth 200mm, packing unit: 30 pcs./box	Pcs.
	F1+220D11	bracket F1+, material EN AW 6060.T66, 2 fixing holes 22/11mm, height 175mm, depth 220mm, packing unit: 30 pcs./box	Pcs.
	F1+235D11	bracket F1+, material EN AW 6060.T66, 2 fixing holes 22/11mm, height 175mm, depth 235mm, packing unit: 25 pcs./box	Pcs.
	F1+255D11	bracket F1+, material EN AW 6060.T66, 2 fixing holes 22/11mm, height 175mm, depth 255mm, packing unit: 25 pcs./box	Pcs.
	F1+285D11	bracket F1+, material EN AW 6060.T66, 2 fixing holes 22/11mm, height 175mm, depth 285mm, packing unit: 25 pcs./box	Pcs.

Product List 2023. Prices in EUR exkl. 20% VAT subject to change without notice.

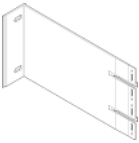

PARTNUMBER	DESCRIPTION	UNIT
	F1+320D11 bracket F1+, material EN AW 6060.T66, 2 fixing holes 22/11mm, height 175mm, depth 320mm, packing unit: 25 pcs./box	Pcs.

Product List 2023. Prices in EUR exkl. 20% VAT subject to change without notice.



ALLFACE
Smart Fixing Systems



F1+brackets (D6,5)

Product List 2023. Prices in EUR exkl. 20% VAT subject to change without notice.

Allface Befestigungstechnologie GmbH
www.allface.com

23/176

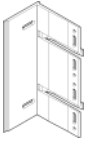
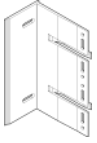
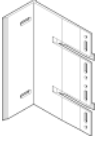
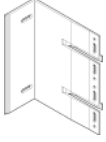
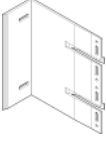

	PARTNUMBER	DESCRIPTION	UNIT
	F1+035D6,5	bracket F1+, material EN AW 6060.T66, 2 fixing holes 22/6,5mm, height 175mm, depth 35mm, packing unit: 100 pcs./box	Pcs.
	F1+050D6,5	bracket F1+, material EN AW 6060.T66, 2 fixing holes 22/6,5mm, height 175mm, depth 50mm, packing unit: 100 pcs./box	Pcs.
	F1+080D6,5	bracket F1+, material EN AW 6060.T66, 2 fixing holes 22/6,5mm, height 175mm, depth 80mm, packing unit: 60 pcs./box	Pcs.
	F1+100D6,5	bracket F1+, material EN AW 6060.T66, 2 fixing holes 22/6,5mm, height 175mm, depth 100mm, packing unit: 50 pcs./box	Pcs.
	F1+115D6,5	bracket F1+, material EN AW 6060.T66, 2 fixing holes 22/6,5mm, height 175mm, depth 115mm, packing unit: 50 pcs./box	Pcs.
	F1+135D6,5	bracket F1+, material EN AW 6060.T66, 2 fixing holes 22/6,5mm, height 175mm, depth 135mm, mmpacking unit: 40 pcs./box	Pcs.
	F1+150D6,5	bracket F1+, material EN AW 6060.T66, 2 fixing holes 22/6,5mm, height 175mm, depth 150mm, packing unit: 40 pcs./box	Pcs.

Product List 2023. Prices in EUR exkl. 20% VAT subject to change without notice.



	PARTNUMBER	DESCRIPTION	UNIT
	F1+170D6,5	bracket F1+, material EN AW 6060.T66, 2 fixing holes 22/6,5mm, height 175mm, depth 170mm, packing unit: 40 pcs./box	Pcs.
	F1+185D6,5	bracket F1+, material EN AW 6060.T66, 2 fixing holes 22/6,5mm, height 175mm, depth 185mm, packing unit: 40 pcs./box	Pcs.
	F1+200D6,5	bracket F1+, material EN AW 6060.T66, 2 fixing holes 22/6,5mm, height 175mm, depth 200mm, packing unit: 30 pcs./box	Pcs.
	F1+220D6,5	bracket F1+, material EN AW 6060.T66, 2 fixing holes 22/6,5mm, height 175mm, depth 220mm, packing unit: 30 pcs./box	Pcs.
	F1+235D6,5	bracket F1+, material EN AW 6060.T66, 2 fixing holes 22/6,5mm, height 175mm, depth 235mm, packing unit: 25 pcs./box	Pcs.
	F1+255D6,5	bracket F1+, material EN AW 6060.T66, 2 fixing holes 22/6,5mm, height 175mm, depth 255mm, packing unit: 25 pcs./box	Pcs.
	F1+285D6,5	bracket F1+, material EN AW 6060.T66, 2 fixing holes 22/6,5mm, height 175mm, depth 285mm, packing unit: 25 pcs./box	Pcs.

Product List 2023. Prices in EUR exkl. 20% VAT subject to change without notice.

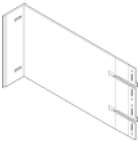

PARTNUMBER	DESCRIPTION	UNIT
	F1+320D6,5 bracket F1+, material EN AW 6060.T66, 2 fixing holes 22/6,5mm, height 175mm, depth 320mm, packing unit: 25 pcs./box	Pcs.

Product List 2023. Prices in EUR exkl. 20% VAT subject to change without notice.



ALLFACE
Smart Fixing Systems







F1+brackets (X5)

Product List 2023. Prices in EUR exkl. 20% VAT subject to change without notice.

Allface Befestigungstechnologie GmbH
www.allface.com

27/176



	PARTNUMBER	DESCRIPTION	UNIT
	F1+035X5	Double Bracket F1+, material EN AW 6060.T66, 5 fixing holes, 3x22/6,5mm & 2x22/11mm, H175mm, D35mm, box quantity: 100 pcs./box	Pcs.
	F1+050X5	Double Bracket F1+, material EN AW 6060.T66, 5 fixing holes, 3x22/6,5mm & 2x22/11mm, H175mm, D50mm, box quantity: 100 pcs./box	Pcs.
	F1+080X5	Double Bracket F1+, material EN AW 6060.T66, 5 fixing holes, 3x22/6,5mm & 2x22/11mm, H175mm, D80mm, box quantity: 60 pcs./box	Pcs.
	F1+100X5	Double Bracket F1+, material EN AW 6060.T66, 5 fixing holes, 3x22/6,5mm & 2x22/11mm, H175mm, D100mm, box quantity: 50 pcs./box	Pcs.
	F1+115X5	Double Bracket F1+, material EN AW 6060.T66, 5 fixing holes, 3x22/6,5mm & 2x22/11mm, H175mm, D115mm, box quantity: 50 pcs./box	Pcs.
	F1+135X5	Double Bracket F1+, material EN AW 6060.T66, 5 fixing holes, 3x22/6,5mm & 2x22/11mm, H175mm, D135mm, box quantity: 40 pcs./box	Pcs.
	F1+150X5	Double Bracket F1+, material EN AW 6060.T66, 5 fixing holes, 3x22/6,5mm & 2x22/11mm, H175mm, D150mm, box quantity: 40 pcs./box	Pcs.

Product List 2023. Prices in EUR exkl. 20% VAT subject to change without notice.



	PARTNUMBER	DESCRIPTION	UNIT
	F1+170X5	Double Bracket F1+, material EN AW 6060.T66, 5 fixing holes, 3x22/6,5mm & 2x22/11mm, H175mm, D170mm, box quantity: 40 pcs./box	Pcs.
	F1+185X5	Double Bracket F1+, material EN AW 6060.T66, 5 fixing holes, 3x22/6,5mm & 2x22/11mm, H175mm, D185mm, box quantity: 40 pcs./box	Pcs.
	F1+200X5	Double Bracket F1+, material EN AW 6060.T66, 5 fixing holes, 3x22/6,5mm & 2x22/11mm, H175mm, D200mm, box quantity: 30 pcs./box	Pcs.
	F1+220X5	Double Bracket F1+, material EN AW 6060.T66, 5 fixing holes, 3x22/6,5mm & 2x22/11mm, H175mm, D220mm, box quantity: 30 pcs./box	Pcs.
	F1+235X5	Double Bracket F1+, material EN AW 6060.T66, 5 fixing holes, 3x22/6,5mm & 2x22/11mm, H175mm, D235mm, box quantity: 25 pcs./box	Pcs.
	F1+255X5	Double Bracket F1+, material EN AW 6060.T66, 5 fixing holes, 3x22/6,5mm & 2x22/11mm, H175mm, D255mm, box quantity: 25 pcs./box	Pcs.
	F1+285X5	Double Bracket F1+, material EN AW 6060.T66, 5 fixing holes, 3x22/6,5mm & 2x22/11mm, H175mm, D285mm, box quantity: 25 pcs./box	Pcs.

Product List 2023. Prices in EUR exkl. 20% VAT subject to change without notice.

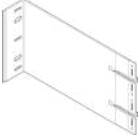

	PARTNUMBER	DESCRIPTION	UNIT
	F1+320X5	Double Bracket F1+, material EN AW 6060.T66, 5 fixing holes, 3x22/6,5mm & 2x22/11mm, H175mm, D320mm, box quantity: 25 pcs./box	Pcs.

Product List 2023. Prices in EUR exkl. 20% VAT subject to change without notice.



ALLFACE
Smart Fixing Systems

F2.brackets (D11)

Product List 2023. Prices in EUR exkl. 20% VAT subject to change without notice.

Allface Befestigungstechnologie GmbH
www.allface.com



31/176



	PARTNUMBER	DESCRIPTION	UNIT
	F2.035D11	bracket F2, material EN AW 6060.T66, 1 fixing hole 22/11mm, 1 round hole 11mm, height 90mm, depth 35mm, box quantity: 100 pcs./box	Pcs.
	F2.050D11	bracket F2, material EN AW 6060.T66, 1 fixing hole 22/11mm, 1 round hole 11mm, height 90mm, depth 50mm, box quantity: 80 pcs./box	Pcs.
	F2.080D11	bracket F2, material EN AW 6060.T66, 1 fixing hole 22/11mm, 1 round hole 11mm, height 90mm, depth 80mm, box quantity: 60 pcs./box	Pcs.
	F2.115D11	bracket F2, material EN AW 6060.T66, 1 fixing hole 22/11mm, 1 round hole 11mm, height 90mm, depth 115mm, box quantity: 60 pcs./box	Pcs.
	F2.150D11	bracket F2, material EN AW 6060.T66, 1 fixing hole 22/11mm, 1 round hole 11mm, height 90mm, depth 150mm, box quantity: 45 pcs./box	Pcs.
	F2.185D11	bracket F2, material EN AW 6060.T66, 1 fixing hole 22/11mm, 1 round hole 11mm, height 90mm, depth 185mm, box quantity: 35 pcs./box	Pcs.

Product List 2023. Prices in EUR exkl. 20% VAT subject to change without notice.



	PARTNUMBER	DESCRIPTION	UNIT
	F2.220D11	bracket F2, material EN AW 6060.T66, 1 fixing hole 22/11mm, 1 round hole 11mm. height 90mm, depth 220mm, box quantity: 28 pcs./box	Pcs.
	F2.235D11	bracket F2, material EN AW 6060.T66, 1 fixing hole 22/11mm, 1 round hole 11mm. height 90mm, depth 235mm, box quantity: 28 pcs./box	Pcs.

Product List 2023. Prices in EUR exkl. 20% VAT subject to change without notice.



ALLFACE
Smart Fixing Systems





F2.brackets (D6,5)

Product List 2023. Prices in EUR exkl. 20% VAT subject to change without notice.

Allface Befestigungstechnologie GmbH
www.allface.com



34/176



	PARTNUMBER	DESCRIPTION	UNIT
	F2.035D6,5	bracket F2, material EN AW 6060.T66, 1 fixing hole 22/6,5mm, 1 round hole 6,5mm. height 90mm, depth 35mm, box quantity: 100 pcs./box	Pcs.
	F2.050D6,5	bracket F2, material EN AW 6060.T66, 1 fixing hole 22/6,5mm, 1 round hole 6,5mm, height 90mm, depth 50mm, box quantity: 80 pcs./box	Pcs.
	F2.080D6,5	bracket F2, material EN AW 6060.T66, 1 fixing hole 22/6,5mm, 1 round hole 6,5mm, height 90mm, depth 80mm, box quantity: 60 pcs./box	Pcs.
	F2.115D6,5	bracket F2, material EN AW 6060.T66, 1 fixing hole 22/6,5mm, 1 round hole 6,5mm, height 90mm, depth 115mm, box quantity: 60 pcs./box	Pcs.
	F2.150D6,5	bracket F2, material EN AW 6060.T66, 1 fixing hole 22/6,5mm, 1 round hole 6,5mm. height 90mm, depth 150mm, box quantity: 45 pcs./box	Pcs.
	F2.185D6,5	bracket F2, material EN AW 6060.T66, 1 fixing hole 22/6,5mm, 1 round hole 6,5mm. height 90mm, depth 185mm, box quantity: 35 pcs./box	Pcs.

Product List 2023. Prices in EUR exkl. 20% VAT subject to change without notice.



	PARTNUMBER	DESCRIPTION	UNIT
	F2.220D6,5	bracket F2, material EN AW 6060.T66, 1 fixing hole 22/6,5mm, 1 round hole 6,5mm. height 90mm, depth 220mm, box quantity: 28 pcs./box	Pcs.
	F2.235D6,5	bracket F2, material EN AW 6060.T66, 1 fixing hole 22/6,5mm, 1 round hole 6,5mm. height 90mm, depth 235mm, box quantity: 28 pcs./box	Pcs.

Product List 2023. Prices in EUR exkl. 20% VAT subject to change without notice.



ALLFACE
Smart Fixing Systems



F2+brackets (D11)

Product List 2023. Prices in EUR exkl. 20% VAT subject to change without notice.

Allface Befestigungstechnologie GmbH
www.allface.com



37/176



	PARTNUMBER	DESCRIPTION	UNIT
	F2+035D11	bracket F2+, material EN AW 6060.T66, 2 fixing hole 22/11mm, 2x round hole 11mm, height 175mm, depth 035mm, box quantity: 30 pcs./box	Pcs.
	F2+050D11	bracket F2+, material EN AW 6060.T66, 2x fixing hole 22/11mm, 2x round hole 11mm, height 175mm, depth 50mm, box quantity: 30 pcs./box	Pcs.
	F2+080D11	bracket F2+, material EN AW 6060.T66, 2x fixing hole 22/11mm, 2x round hole 11mm, height 175mm, depth 80mm, box quantity: 30 pcs./box	Pcs.
	F2+115D11	bracket F2+, material EN AW 6060.T66, 2x fixing hole 22/11mm, 2x round hole 11mm, height 175mm, depth 115mm, box quantity: 30 pcs./box	Pcs.
	F2+150D11	bracket F2+, material EN AW 6060.T66, 2x fixing hole 22/11mm, 2x round hole 11mm, height 175mm, depth 150mm, box quantity: 20 pcs./box	Pcs.
	F2+185D11	bracket F2+, material EN AW 6060.T66, 2x fixing hole 22/11mm, 2x round hole 11mm, height 175mm, depth 185mm, box quantity: 15 pcs./box	Pcs.

Product List 2023. Prices in EUR exkl. 20% VAT subject to change without notice.



	PARTNUMBER	DESCRIPTION	UNIT
	F2+220D11	bracket F2+, material EN AW 6060.T66, 2 fixing hole 22/11mm, 2x round hole 11mm, height 175mm, depth 220mm, box quantity: 12 pcs./box	Pcs.
	F2+235D11	bracket F2+, material EN AW 6060.T66, 2 fixing hole 22/11mm, 2x round hole 11mm, height 175mm, depth 235mm, box quantity: 12 pcs./box	Pcs.

Product List 2023. Prices in EUR exkl. 20% VAT subject to change without notice.



ALLFACE
Smart Fixing Systems







F2+brackets (D6,5)

Product List 2023. Prices in EUR exkl. 20% VAT subject to change without notice.

Allface Befestigungstechnologie GmbH
www.allface.com



40/176



	PARTNUMBER	DESCRIPTION	UNIT
	F2+035D6,5	bracket F2+, material EN AW 6060.T66, 2 fixing hole 22/6,5mm, 2x round hole 6,5mm, height 175mm, depth 035mm, box quantity: 30 pcs./box	Pcs.
	F2+050D6,5	bracket F2+, material EN AW 6060.T66, 2x fixing hole 22/6,5mm, 2x round hole 6,5mm, height 175mm, depth 50mm, box quantity: 30 pcs./box	Pcs.
	F2+080D6,5	bracket F2+, material EN AW 6060.T66, 2x fixing hole 22/6,5mm, 2x round hole 6,5mm, height 175mm, depth 80mm, box quantity: 30 pcs./box	Pcs.
	F2+115D6,5	bracket F2+, material EN AW 6060.T66, 2x fixing hole 22/6,5mm, 2x round hole 6,5mm, height 175mm, depth 115mm, box quantity: 30 pcs./box	Pcs.
	F2+150D6,5	bracket F2+, material EN AW 6060.T66, 2x fixing hole 22/6,5mm, 2x round hole 6,5mm, height 175mm, depth 150mm, box quantity: 20 pcs./box	Pcs.
	F2+185D6,5	bracket F2+, material EN AW 6060.T66, 2x fixing hole 22/6,5mm, 2x round hole 6,5mm, height 175mm, depth 185mm, box quantity: 15 pcs./box	Pcs.

Product List 2023. Prices in EUR exkl. 20% VAT subject to change without notice.



	PARTNUMBER	DESCRIPTION	UNIT
	F2+220D6,5	bracket F2+, material EN AW 6060.T66, 2 fixing hole 22/6,5mm, 2x round hole 6,5mm, height 175mm, depth 220mm, box quantity: 12 pcs./box	Pcs.
	F2+235D6,5	bracket F2+, material EN AW 6060.T66, 2 fixing hole 22/6,5mm, 2x round hole 6,5mm, height 175mm, depth 235mm, box quantity: 12 pcs./box	Pcs.

Product List 2023. Prices in EUR exkl. 20% VAT subject to change without notice.



ALLFACE
Smart Fixing Systems

F3.brackets

Product List 2023. Prices in EUR exkl. 20% VAT subject to change without notice.

Allface Befestigungstechnologie GmbH
www.allface.com

43/176

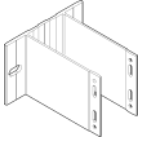

	PARTNUMBER	DESCRIPTION	UNIT
	F3.080.060.90D11X2	bracket F3.080.060.90D11X2, material EN AW 6063.T66, 2 fixing holes 22/11mm, height 90mm, depth 80mm, opening space 60mm	Pcs.
	F3.080.060.90D6,5X2	bracket F3.080.060.90D6,5X2, material EN AW 6063.T66, 2 fixing holes 22/6,5mm, height 90mm, depth 80mm, opening space 60mm	Pcs.
	F3.135.060.90D11X2	bracket F3.135.060.90D11X2, material EN AW 6063.T66, 2 fixing holes 22/11mm, height 90mm, depth 135mm, opening space 60mm	Pcs.
	F3.135.060.90D6,5X2	bracket F3.135.060.90D6,5X2, material EN AW 6063.T66, 2 fixing holes 22/6,5mm, height 90mm, depth 135mm, opening space 60mm	Pcs.

Product List 2023. Prices in EUR exkl. 20% VAT subject to change without notice.



ALLFACE
Smart Fixing Systems

F3+brackets

Product List 2023. Prices in EUR exkl. 20% VAT subject to change without notice.

Allface Befestigungstechnologie GmbH
www.allface.com

45/176



	PARTNUMBER	DESCRIPTION	UNIT
	F3+080.060.200D11	bracket F3+080.060.200D11, material EN AW 6063.T66, 4 fixing holes 22/11mm, height 200mm, depth 80mm, opening space 60mm	Pcs.
	F3+080.060.200D11X2	bracket F3+080.060.200D11x2, material EN AW 6063.T66, 2 fixing holes 22/11mm, height 200mm, depth 80mm, opening space 60mm	Pcs.
	F3+080.060.200D6,5	bracket F3+080.060.200D6,5, material EN AW 6063.T66, 4 fixing holes 22/6,5mm, height 200mm, depth 80mm, opening space 60mm	Pcs.
	F3+080.060.250D11	bracket F3+080.060.250D11, material EN AW 6063.T66, 4 fixing holes 22/11mm, height 250mm, depth 80mm, opening space 60mm	Pcs.
	F3+080.060.250D6,5	bracket F3+080.060.250D6,5, material EN AW 6063.T66, 4 fixing holes 22/6,5mm, height 250mm, depth 80mm, opening space 60mm	Pcs.
	F3+080.060.350D11	bracket F3+080.060.350D11, material EN AW 6063.T66, 4 fixing holes 22/11mm, height 350mm, depth 80mm, opening space 60mm	Pcs.
	F3+080.060.350D6,5	bracket F3+080.060.350D6,5, material EN AW 6063.T66, 4 fixing holes 22/6,5mm, height 350mm, depth 80mm, opening space 60mm	Pcs.

Product List 2023. Prices in EUR exkl. 20% VAT subject to change without notice.



	PARTNUMBER	DESCRIPTION	UNIT
	F3+135.060.200D11	bracket F3+135.060.200D11, material EN AW 6063.T66, 4 fixing holes 22/11mm, height 200mm, depth 135mm, opening space 60mm	Pcs.
	F3+135.060.200D11x2	bracket F3+135.060.200D11x2, material EN AW 6063.T66, 2 fixing holes 22/11mm, height 200mm, depth 135mm, opening space 60mm	Pcs.
	F3+135.060.200D6,5	bracket F3+135.060.200D6,5, material EN AW 6063.T66, 4 fixing holes 22/6,5mm, height 200mm, depth 135mm, opening space 60mm	Pcs.
	F3+135.060.250D11	bracket F3+135.060.250D11, material EN AW 6063.T66, 4 fixing holes 22/11mm, height 250mm, depth 135mm, opening space 60mm	Pcs.
	F3+135.060.250D6,5	bracket F3+135.060.250D6,5, material EN AW 6063.T66, 4 fixing holes 22/6,5mm, height 250mm, depth 135mm, opening space 60mm	Pcs.
	F3+135.060.350D11	bracket F3+135.060.350D11, material EN AW 6063.T66, 4 fixing holes 22/11mm, height 350mm, depth 135mm, opening space 60mm	Pcs.
	F3+135.060.350D6,5	bracket F3+135.060.350D6,5, material EN AW 6063.T66, 4 fixing holes 22/6,5mm, height 350mm, depth 135mm, opening space 60mm	Pcs.

Product List 2023. Prices in EUR exkl. 20% VAT subject to change without notice.



ALLFACE
Smart Fixing Systems







F4.brackets

Product List 2023. Prices in EUR exkl. 20% VAT subject to change without notice.

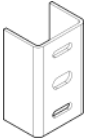
Allface Befestigungstechnologie GmbH
www.allface.com





48/176



	PARTNUMBER	DESCRIPTION	UNIT
	F4.05004030X3	bracket F4, material EN AW 5754.H22, 2 fixing holes 22/6,5mm, 1x fixing holes 22/11mm, opening width 50mm, depth 40mm, thickness 3mm, height 90mm	Pcs.
	F4.05005030X3	bracket F4, material EN AW 5754.H22, 2 fixing holes 22/6,5mm, 1x fixing holes 22/11mm, opening width 50mm, depth 50mm, thickness 3mm, height 90mm	Pcs.
	F4.05008030X3	bracket F4, material EN AW 5754.H22, 2 fixing holes 22/6,5mm, opening width 50mm, depth 80mm, thickness 3mm, height 90mm	Pcs.
	F4.05010030X3	bracket F4, material EN AW 5754.H22, 2 fixing holes 22/6,5mm, 1x fixing holes 22/11mm, opening width 50mm, depth 100mm, thickness 3mm, height 90mm	Pcs.
	F4.05011530X3	bracket F4, material EN AW 5754.H22, 2 fixing holes 22/6,5mm, 1x fixing holes 22/11mm, opening width 50mm, depth 115mm, thickness 3mm, height 90mm	Pcs.
	F4.05013530X3	bracket F4, material EN AW 5754.H22, 2 fixing holes 22/6,5mm, 1x fixing holes 22/11mm, opening width 50mm, depth 135mm, thickness 3mm, height 90mm	Pcs.

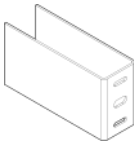





Product List 2023. Prices in EUR exkl. 20% VAT subject to change without notice.

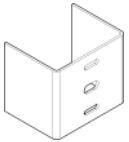

	PARTNUMBER	DESCRIPTION	UNIT
	F4.05015030X3	bracket F4, material EN AW 5754.H22, 2 fixing holes 22/6,5mm, 1x fixing holes 22/11mm, opening width 50mm, depth 150mm, thickness 3mm, height 90mm	Pcs.
	F4.05017030X3	bracket F4, material EN AW 5754.H22, 2 fixing holes 22/6,5mm, 1x fixing holes 22/11mm, opening width 50mm, depth 170mm, thickness 3mm, height 90mm	Pcs.
	F4.05018530X3	bracket F4, material EN AW 5754.H22, 2 fixing holes 22/6,5mm, 1x fixing holes 22/11mm, opening width 50mm, depth 185mm, thickness 3mm, height 90mm	Pcs.
	F4.05020030X3	bracket F4, material EN AW 5754.H22, 2 fixing holes 22/6,5mm, 1x fixing holes 22/11mm, opening width 50mm, depth 200mm, thickness 3mm, height 90mm	Pcs.
	F4.10004030X3	bracket F4, material EN AW 5754.H22, 2 fixing holes 22/6,5mm, 1x fixing holes 22/11mm, opening width 100mm, depth 50mm, thickness 3mm, height 90mm	Pcs.
	F4.10005030X3	bracket F4, material EN AW 5754.H22, 2 fixing holes 22/6,5mm, 1x fixing holes 22/11mm, opening width 100mm, depth 50mm, thickness 3mm, height 90mm	Pcs.

Product List 2023. Prices in EUR exkl. 20% VAT subject to change without notice.

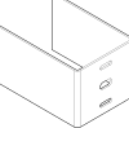

	PARTNUMBER	DESCRIPTION	UNIT
	F4.10008030X3	bracket F4, material EN AW 5754.H22, 2 fixing holes 22/6,5mm, 1x fixing holes 22/11mm, opening width 100mm, depth 80mm, thickness 3mm, height 90mm	Pcs.
	F4.10010030X3	bracket F4, material EN AW 5754.H22, 2 fixing holes 22/6,5mm, 1x fixing holes 22/11mm, opening width 100mm, depth 100mm, thickness 3mm, height 90mm	Pcs.
	F4.10011530X3	bracket F4, material EN AW 5754.H22, 2 fixing holes 22/6,5mm, 1x fixing holes 22/11mm, opening width 100mm, depth 115mm, thickness 3mm, height 90mm	Pcs.
	F4.10013530X3	bracket F4, material EN AW 5754.H22, 2 fixing holes 22/6,5mm, 1x fixing holes 22/11mm, opening width 100mm, depth 135mm, thickness 3mm, height 90mm	Pcs.
	F4.10015030X3	bracket F4, material EN AW 5754.H22, 2 fixing holes 22/6,5mm, 1x fixing holes 22/11mm, opening width 100mm, depth 150mm, thickness 3mm, height 90mm	Pcs.
	F4.10017030X3	bracket F4, material EN AW 5754.H22, 2 fixing holes 22/6,5mm, 1x fixing holes 22/11mm, opening width 100mm, depth 170mm, thickness 3mm, height 90mm	Pcs.

Product List 2023. Prices in EUR exkl. 20% VAT subject to change without notice.

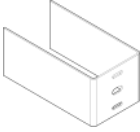

	PARTNUMBER	DESCRIPTION	UNIT
	F4.10018530X3	bracket F4, material EN AW 5754.H22, 2 fixing holes 22/6,5mm, 1x fixing holes 22/11mm, opening width 100mm, depth 185mm, thickness 3mm, height 90mm	Pcs.
	F4.10020030X3	bracket F4, material EN AW 5754.H22, 2 fixing holes 22/6,5mm, 1x fixing holes 22/11mm, opening width 100mm, depth 200mm, thickness 3mm, height 90mm	Pcs.

Product List 2023. Prices in EUR exkl. 20% VAT subject to change without notice.



ALLFACE
Smart Fixing Systems







F4+brackets

Product List 2023. Prices in EUR exkl. 20% VAT subject to change without notice.

Allface Befestigungstechnologie GmbH
www.allface.com





53/176



	PARTNUMBER	DESCRIPTION	UNIT
	F4+05004030X5	bracket F4+, material EN AW 5754.H22, 3 fixing holes 22/6,5mm, 2 fixing holes 22/11mm, opening width 50mm, depth 40mm, thickness 3mm, height 175mm	Pcs.
	F4+05005030X5	bracket F4+, material EN AW 5754.H22, 3 fixing holes 22/6,5mm, 2 fixing holes 22/11mm, opening width 50mm, depth 50mm, thickness 3mm, height 175mm	Pcs.
	F4+05008030X5	bracket F4+, material EN AW 5754.H22, 5 fixing holes 22/6,5mm, opening width 50mm, depth 80mm, thickness 3mm, height 175mm	Pcs.
	F4+05010030X5	bracket F4+, material EN AW 5754.H22, 3 fixing holes 22/6,5mm, 2 fixing holes 22/11mm, opening width 50mm, depth 100mm, thickness 3mm, height 175mm	Pcs.
	F4+05011530X5	bracket F4+, material EN AW 5754.H22, 3 fixing holes 22/6,5mm, 2 fixing holes 22/11mm, opening width 50mm, depth 115mm, thickness 3mm, height 175mm	Pcs.
	F4+05013530X5	bracket F4+, material EN AW 5754.H22, 3 fixing holes 22/6,5mm, 2 fixing holes 22/11mm, opening width 50mm, depth 135mm, thickness 3mm, height 175mm	Pcs.

Product List 2023. Prices in EUR exkl. 20% VAT subject to change without notice.

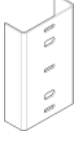
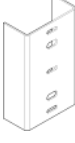

	PARTNUMBER	DESCRIPTION	UNIT
	F4+05015030X5	bracket F4+, material EN AW 5754.H22, 3 fixing holes 22/6,5mm, 2 fixing holes 22/11mm, opening width 50mm, depth 150mm, thickness 3mm, height 175mm	Pcs.
	F4+05017030X5	bracket F4+, material EN AW 5754.H22, 3 fixing holes 22/6,5mm, 2 fixing holes 22/11mm, opening width 50mm, depth 170mm, thickness 3mm, height 175mm	Pcs.
	F4+05018530X5	bracket F4+, material EN AW 5754.H22, 3 fixing holes 22/6,5mm, 2 fixing holes 22/11mm, opening width 50mm, depth 185mm, thickness 3mm, height 175mm	Pcs.
	F4+05020030X5	bracket F4+, material EN AW 5754.H22, 3 fixing holes 22/6,5mm, 2 fixing holes 22/11mm, opening width 50mm, depth 200mm, thickness 3mm, height 175mm	Pcs.
	F4+10004030X5	bracket F4+, material EN AW 5754.H22, 3 fixing holes 22/6,5mm, 2 fixing holes 22/11mm, opening width 100mm, depth 40mm, thickness 3mm, height 175mm	Pcs.
	F4+10005030X5	bracket F4+, material EN AW 5754.H22, 3 fixing holes 22/6,5mm, 2 fixing holes 22/11mm, opening width 100mm, depth 50mm, thickness 3mm, height 175mm	Pcs.



Product List 2023. Prices in EUR exkl. 20% VAT subject to change without notice.



	PARTNUMBER	DESCRIPTION	UNIT
	F4+10008030X5	bracket F4+, material EN AW 5754.H22, 3 fixing holes 22/6,5mm, 2 fixing holes 22/11mm, opening width 100mm, depth 80mm, thickness 3mm, height 175mm	Pcs.
	F4+10010030X5	bracket F4+, material EN AW 5754.H22, 3 fixing holes 22/6,5mm, 2 fixing holes 22/11mm, opening width 100mm, depth 100mm, thickness 3mm, height 175mm	Pcs.
	F4+10011530X5	bracket F4+, material EN AW 5754.H22, 3 fixing holes 22/6,5mm, 2 fixing holes 22/11mm, opening width 100mm, depth 115mm, thickness 3mm, height 175mm	Pcs.
	F4+10013530X5	bracket F4+, material EN AW 5754.H22, 3 fixing holes 22/6,5mm, 2 fixing holes 22/11mm, opening width 100mm, depth 135mm, thickness 3mm, height 175mm	Pcs.
	F4+10015030X5	bracket F4+, material EN AW 5754.H22, 3 fixing holes 22/6,5mm, 2 fixing holes 22/11mm, opening width 100mm, depth 150mm, thickness 3mm, height 175mm	Pcs.
	F4+10017030X5	bracket F4+, material EN AW 5754.H22, 3 fixing holes 22/6,5mm, 2 fixing holes 22/11mm, opening width 100mm, depth 170mm, thickness 3mm, height 175mm	Pcs.

Product List 2023. Prices in EUR exkl. 20% VAT subject to change without notice.



	PARTNUMBER	DESCRIPTION	UNIT
	F4+10018530X5	bracket F4+, material EN AW 5754.H22, 3 fixing holes 22/6,5mm, 2 fixing holes 22/11mm, opening width 100mm, depth 185mm, thickness 3mm, height 175mm	Pcs.
	F4+10020030X5	bracket F4+, material EN AW 5754.H22, 3 fixing holes 22/6,5mm, 2 fixing holes 22/11mm, opening width 100mm, depth 200mm, thickness 3mm, height 175mm	Pcs.

Product List 2023. Prices in EUR exkl. 20% VAT subject to change without notice.



ALLFACE
Smart Fixing Systems



Y-brackets

Product List 2023. Prices in EUR exkl. 20% VAT subject to change without notice.

Allface Befestigungstechnologie GmbH
www.allface.com

58/176

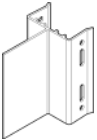

	PARTNUMBER	DESCRIPTION	UNIT
	Y-05408520.90	Y-bracket 50, material EN AW 6063.T66, height 90mm, thickness 2mm	Pcs.
	Y-05408520.175	Y-bracket 50, material EN AW 6063.T66, height 175mm, thickness 2mm	Pcs.

Product List 2023. Prices in EUR exkl. 20% VAT subject to change without notice.



ALLFACE
Smart Fixing Systems



Y-brackets 100mm

Product List 2023. Prices in EUR exkl. 20% VAT subject to change without notice.

Allface Befestigungstechnologie GmbH
www.allface.com

60/176

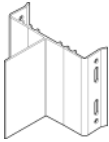

	PARTNUMBER	DESCRIPTION	UNIT
	Y-10408520.90	Y-bracket 100, material EN AW 6063.T66, height 90mm, thickness 2mm	Pcs.
	Y-10408520.175	Y-bracket 100, material EN AW 6063.T66, height 175mm, thickness 2mm	Pcs.

Product List 2023. Prices in EUR exkl. 20% VAT subject to change without notice.



ALLFACE
Smart Fixing Systems

L-profiles

Product List 2023. Prices in EUR exkl. 20% VAT subject to change without notice.

Allface Befestigungstechnologie GmbH
www.allface.com

62/176

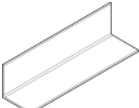
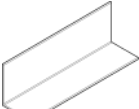

	PARTNUMBER	DESCRIPTION	UNIT
	A-L03003020	L-profile 30/30/2,0mm, material EN AW 6060.T66, length 6.000mm	Rm.
	A-L03003030	L-profile 30/30/3,0mm, material EN AW 6060.T66, length 6.000mm	Rm.
	A-L04002020	L-profile 40/20/2,0mm, material EN AW 6060.T66, length 6.000mm	Rm.
	A-L04003020	L-profile 40/30/2,0mm, material EN AW 6060.T66, length 6.000mm	Rm.
	A-L04004020	L-profile 40/40/2,0mm, material EN AW 6060.T66, length 6.000mm	Rm.
	A-L04005020	L-profile 40/50/2,0mm, material EN AW 6063.T66, length 6.000mm	Rm.
	A-L04005020-351	L-profile 40/50/2,0mm, material EN AW 6063.T66, length 6.000mm, anodized E6/C35 (black) 12-15µ	Rm.



Product List 2023. Prices in EUR exkl. 20% VAT subject to change without notice.



	PARTNUMBER	DESCRIPTION	UNIT
	A-L04005020-352	L-profile 40/50/2,0mm, material EN AW 6063.T66, length 6.000mm, anodized E6/C35 (black) 20µ	Rm.
	A-L04006020	L-profile 40/60/2,0mm, material EN AW 6063.T66, length 6.000mm	Rm.
	A-L04006020-351	L-profile 40/60/2,0mm, material EN AW 6063.T66, length 6.000mm, anodized E6/C35 (black) 12-15µ	Rm.
	A-L04006020-352	L-profile 40/60/2,0mm, material EN AW 6063.T66, length 6.000mm, anodized E6/C35 (black) 20µ	Rm.
	A-L04006025	L-profile 40/60/2,5mm, material EN AW 6063.T66, length 6.000mm	Rm.
	A-L04006030	L-profile 40/60/3,0mm, material EN AW 6063.T66, length 6.000mm	Rm.
	A-L04014025	L-profile 40/140/2,5mm, material EN AW 6063.T66, length 6.000mm	Rm.

Product List 2023. Prices in EUR exkl. 20% VAT subject to change without notice.

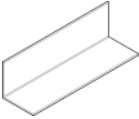
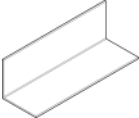

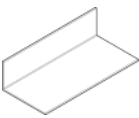
	PARTNUMBER	DESCRIPTION	UNIT
	A-L04504520	L-profile 45/45/2,0mm, material EN AW 6060.T66, length 6.000mm	Rm.
	A-L05005020	L-profile 50/50/2,0mm, material EN AW 6060.T66, length 6.000mm	Rm.
	A-L06006020	L-profile 60/60/2,0mm, material EN AW 6060.T66, length 6.000mm	Rm.
	A-L07004020	L-profile 70/40/2,0mm, material EN AW 6063.T66, length 6.000mm	Rm.

Product List 2023. Prices in EUR exkl. 20% VAT subject to change without notice.



ALLFACE
Smart Fixing Systems

T-profiles

Product List 2023. Prices in EUR exkl. 20% VAT subject to change without notice.

Allface Befestigungstechnologie GmbH
www.allface.com

66/176

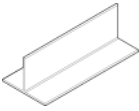
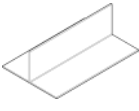

	PARTNUMBER	DESCRIPTION	UNIT
	A-T06005020	T-profile 60/50/2,0mm, material EN AW 6063.T66, length 6.000mm	Rm.
	A-T07005028	T-profile 70/50/2,8mm, material EN AW 6063.T66, length 6.000mm	Rm.
	A-T08005020	T-profile 80/50/2,0mm, material EN AW 6060.T66, length 6.000mm	Rm.
	A-T08014025	T-profile 80/140/2,5mm, material EN AW 6063.T66, length 6.000mm	Rm.
	A-T09409425	T-profile 94/94/2,5mm, material EN AW 6060.T66, length 6.000mm	Rm.
	A-T10005020	T-profile 100/50/2,0mm, material EN AW 6063.T66, length 6.000mm	Rm.
	A-T10005020-351	T-profile 100/50/2,0mm, material EN AW 6063.T66, length 6.000mm, anodized E6/C35 (black) 12-15µ	Rm.





Product List 2023. Prices in EUR exkl. 20% VAT subject to change without notice.

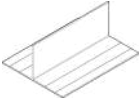
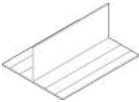

	PARTNUMBER	DESCRIPTION	UNIT
	A-T10005020-352	T-profile 100/50/2,0mm, material EN AW 6063.T66, length 6.000mm, anodized E6/C35 (black) 20µ	Rm.
	A-T10006020	T-profile 100/60/2,0mm, material EN AW 6063.T66, length 6.000mm	Rm.
	A-T10006020-351	T-profile 100/60/2,0mm, material EN AW 6063.T66, length 6.000mm, anodized E6/C35 (black) 12-15µ	Rm.
	A-T10006025	T-profile 100/60/2,5mm, material EN AW 6063.T66, length 6.000mm	Rm.
	A-T12004020	T-profile 120/40/2,0mm, material EN AW 6060.T68, length 6.000mm	Rm.
	A-T12005030	T-profile 120/50/3,0mm, material EN AW 6063.T66, length 6.000mm	Rm.
	A-T12005030-351	T-profile 120/50/3,0mm, material EN AW 6063.T66, length 6.000mm, anodized E6/C35 (black) 12-15µ	Rm.

Product List 2023. Prices in EUR exkl. 20% VAT subject to change without notice.



	PARTNUMBER	DESCRIPTION	UNIT
	A-T12006020	T-profile 120/60/2,0mm, material EN AW 6063.T66, length 6.000mm	Rm.
	A-T12006020-351	T-profile 120/60/2,0mm, material EN AW 6063.T66, length 6.000mm, anodized E6/C35 (black) 12-15µ	Rm.
	A-T12006020-352	T-profile 120/60/2,0mm, material EN AW 6063.T66, length 6.000mm, anodized E6/C35 (black) 20µ	Rm.
	A-T12006040	T-profile 120/60/4,0mm, material EN AW 6063.T66, length 6.000mm	Rm.
	A-T14006020	T-profile 140/60/2,0mm, material EN AW 6063.T66, length 6.000mm	Rm.
	A-T14014035	T-profile 140/140/3,5mm, material EN AW 6063.T66	Rm.

Product List 2023. Prices in EUR exkl. 20% VAT subject to change without notice.



ALLFACE
Smart Fixing Systems

Z-profiles

Product List 2023. Prices in EUR exkl. 20% VAT subject to change without notice.

Allface Befestigungstechnologie GmbH
www.allface.com



70/176



	PARTNUMBER	DESCRIPTION	UNIT
	A-Z08102525	Z-profile 40/25/45/2,5mm, material EN AW 6063.T66, length 6.000mm	Rm.
	A-Z08102525.LL	Z-profile 40/25/45/2,5mm, material EN AW 6063.T66, length 6.000mm including elongated holes 6,7/20mm, interval 80mm	Rm.
	A-Z08102525.LL.11	Z-profile 40/25/45/2,5mm, material EN AW 6063.T66, length 6.000mm including elongated holes 11/20mm, interval 80mm	Rm.
	A-Z08102525-351	Z-profile 40/25/45/2,5mm, material EN AW 6063.T66, length 6.000mm, anodized E6/C35 (black) 12-15µ	Rm.
	A-Z08102525.LL-351	Z-profile 40/25/45/2,5mm, material EN AW 6063.T66, length 6.000mm including elongated holes 6,7/20mm, interval 80mm, anodized E6/C35 (black) 12-15µ	Rm.
	A-Z08102525-352	Z-profile 40/25/45/2,5mm, material EN AW 6063.T66, length 6.000mm, anodized E6/C35 (black) 20µ	Rm.
	A-Z08102525.LL-352	Z-profile 40/25/45/2,5mm, material EN AW 6063.T66, length 6.000mm including elongated holes 6,7/20mm, interval 80mm, anodized E6/C35 (black) 20µ	Rm.





Product List 2023. Prices in EUR exkl. 20% VAT subject to change without notice.



	PARTNUMBER	DESCRIPTION	UNIT
	A-Z08102530	Z-profile 40/25/45/3,0mm, material EN AW 6063.T66, length 6.000mm	Rm.
	A-Z08102530.LL	Z-profile 40/25/45/3,0mm, material EN AW 6063.T66, length 6.000mm including elongated holes 6,7/20mm, interval 80mm	Rm.
	A-Z08102530.LL11	Z-profile 40/25/45/3,0mm, material EN AW 6063.T66, length 6.000mm including elongated holes 11/20mm, interval 80mm	Rm.
	A-Z07003020	Z-profile 45/30/31/2,0mm, material EN AW 6063.T66, length 6.000mm	Rm.
	A-Z07003020.LL	Z-profile 45/30/31/2,0mm, material EN AW 6063.T66, length 6.000mm including elongated holes 6,7/20mm, interval 80mm	Rm.
	A-Z07003020.LL11	Z-profile 45/30/31/2,0mm, material EN AW 6063.T66, length 6.000mm including elongated holes 11/20mm, interval 80mm	Rm.
	A-Z07003020-351	Z-profile 45/30/31/2,0mm, material EN AW 6063.T66, length 6.000mm, anodized E6/C35 (black) 12-15µ	Rm.

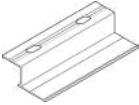

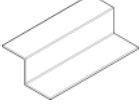

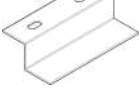
Product List 2023. Prices in EUR exkl. 20% VAT subject to change without notice.



	PARTNUMBER	DESCRIPTION	UNIT
	A-Z07003020.LL-351	Z-profile 45/30/31/2,0mm, material EN AW 6063.T66, length 6.000mm including elongated holes 6,7/20mm, interval 80mm, anodized E6/C35 (black) 12-15µ	Rm.
	A-Z07003020.LL11-351	Z-profile 45/30/31/2,0mm, material EN AW 6063.T66, length 6.000mm including elongated holes 11/20mm, interval 80mm, anodized E6/C35 (black) 12-15µ	Rm.
	A-Z07003020-352	Z-profile 45/30/31/2,0mm, material EN AW 6063.T66, length 6.000mm, anodized E6/C35 (black) 20µ	Rm.
	A-Z07003020.LL-352	Z-profile 45/30/31/2,0mm, material EN AW 6063.T66, length 6.000mm including elongated holes 6,7/20mm, interval 80mm, anodized E6/C35 (black) 20µ	Rm.
	A-Z08104025	Z-profile 40/40/45/2,5mm, material EN AW 6063.T66, length 6.000mm	Rm.
	A-Z08104025.LL	Z-profile 40/40/45/2,5mm, material EN AW 6063.T66, length 6.000mm including elongated holes 6,7/20mm, interval 80mm	Rm.
	A-Z08104025.LL11	Z-profile 40/40/45/2,5mm, material EN AW 6063.T66, length 6.000mm including elongated holes 11/20mm, interval 80mm	Rm.

Product List 2023. Prices in EUR exkl. 20% VAT subject to change without notice.

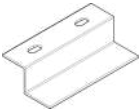
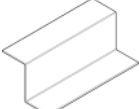

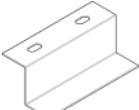
	PARTNUMBER	DESCRIPTION	UNIT
	A-Z08104030	Z-profile 40/40/45/3,0mm, material EN AW 6063.T66, length 6.000mm	Rm.
	A-Z08104030.LL	Z-profile 40/40/45/3,0mm, material EN AW 6063.T66, length 6.000mm including elongated holes 6,7/20mm, interval 80mm	Rm.
	A-Z08104030.LL11	Z-profile 40/40/45/3,0mm, material EN AW 6063.T66, length 6.000mm including elongated holes 11/20mm, interval 80mm	Rm.
	A-Z07805620	Z-profile 40/56/40/2,0mm, material EN AW 6063.T66, length 6.000mm	Rm.
	A-Z07805620.LL	Z-profile 40/56/40/2,0mm, material EN AW 6063.T66, length 6.000mm, including elongated holes 6,7/20mm, interval 80mm	Rm.
	A-Z07805620.LL11	Z-profile 40/56/40/2,0mm, material EN AW 6063.T66, length 6.000mm, including elongated holes 11/20mm, interval 80mm	Rm.

Product List 2023. Prices in EUR exkl. 20% VAT subject to change without notice.



ALLFACE
Smart Fixing Systems

Omega profiles

Product List 2023. Prices in EUR exkl. 20% VAT subject to change without notice.

Allface Befestigungstechnologie GmbH
www.allface.com

75/176



	PARTNUMBER	DESCRIPTION	UNIT
	A-H09001530	Omega-profile 90/15/3,0mm, material EN AW 6063.T66, length 6.000mm	Rm.
	A-H12202520	Omega-profile 122/25/2,0mm, material EN AW 6063.T66, length 6.000mm	Rm.
	A-H12202520.LL	Omega-profile 122/25/2,0mm, material EN AW 6063.T66, length 6.000mm including elongated holes 6,7/20mm, interval 80mm	Rm.
	A-H12202520.LL.11	Omega-profile 122/25/2,0mm, material EN AW 6063.T66, length 6.000mm including elongated holes 11/20mm, interval 80mm	Rm.
	A-H12202520-351	Omega-profile 122/25/2,0mm, material EN AW 6063.T66, length 6.000mm, anodized E6/C35 (black) 12-15µ	Rm.
	A-H12202520.LL-351	Omega-profile 122/25/2,0mm, material EN AW 6063.T66, length 6.000mm including elongated holes 6,7/20mm, interval 80mm, anodized E6/C35 (black) 12-15µ	Rm.
	A-H12202520-352	Omega-profile 122/25/2,0mm, material EN AW 6063.T66, length 6.000mm, anodized E6/C35 (black) 20µ	Rm.

Product List 2023. Prices in EUR exkl. 20% VAT subject to change without notice.



	PARTNUMBER	DESCRIPTION	UNIT
	A-H12202520.LL-352	Omega-profile 122/25/2,0mm, material EN AW 6063.T66, length 6.000mm including elongated holes 6,7/20mm, interval 80mm, anodized E6/C35 (black) 20µ	Rm.
	A-H12202530	Omega-profile 122/25/3,0mm, material EN AW 6063.T66, length 6.000mm	Rm.
	A-H12202530.LL	Omega-profile 122/25/3,0mm, material EN AW 6063.T66, length 6.000mm including elongated holes 6,7/20mm, interval 80mm	Rm.
	A-H12202530.LL11	Omega-profile 122/25/3,0mm, material EN AW 6063.T66, length 6.000mm including elongated holes 11/20mm, interval 80mm	Rm.
	A-H11403020	Omega-profile 114/30/2,0mm, material EN AW 6063.T66, length 6.000mm	Rm.
	A-H11403020.LL	Omega-profile 114/30/2,0mm, material EN AW 6063.T66, length 6.000mm including elongated hole 6,7/20mm, interval 80mm	Rm.
	A-H11403020.LL11	Omega-profile 114/30/2,0mm, material EN AW 6063.T66, length 6.000mm including elongated hole 11/20mm, interval 80mm	Rm.

Product List 2023. Prices in EUR exkl. 20% VAT subject to change without notice.



	PARTNUMBER	DESCRIPTION	UNIT
	A-H11403020-351	Omega-profile 114/30/2,0mm, material EN AW 6063.T66, length 6.000mm, anodized E6/C35 (black) 12-15µ	Rm.
	A-H11403020.LL-351	Omega-profile 114/30/2,0mm, material EN AW 6063.T66, length 6.000mm including elongated hole 6,7/20mm, interval 80mm, anodized E6/C35 (black) 12-15µ	Rm.
	A-H11403020.LL11-351	Omega-profile 114/30/2,0mm, material EN AW 6063.T66, length 6.000mm including elongated hole 11/20mm, interval 80mm, anodized E6/C35 (black) 12-15µ	Rm.
	A-H11403020-352	Omega-profile 114/30/2,0mm, material EN AW 6063.T66, length 6.000mm, anodized E6/C35 (black) 20µ	Rm.
	A-H11403020.LL-352	Omega-profile 114/30/2,0mm, material EN AW 6063.T66, length 6.000mm including elongated hole 6,7/20mm, interval 80mm, anodized E6/C35 (black) 20µ	Rm.
	A-H12204020	Omega-profile 122/40/2,0mm, material EN AW 6063.T66, length 6.000mm	Rm.
	A-H12204020.LL	Omega-profile 122/40/2,0mm, material EN AW 6063.T66, length 6.000mm including elongated hole 6,7/20mm, interval 80mm	Rm.

Product List 2023. Prices in EUR exkl. 20% VAT subject to change without notice.



	PARTNUMBER	DESCRIPTION	UNIT
	A-H12204020.LL11	Omega-profile 122/40/2,0mm, material EN AW 6063.T66, length 6.000mm including elongated hole 11/20mm, interval 80mm	Rm.
	A-H12204030	Omega-profile 122/40/3,0mm, material EN AW 6063.T66, length 6.000mm	Rm.
	A-H12204030.LL	Omega-profile 122/40/3,0mm, material EN AW 6063.T66, length 6.000mm including elongated hole 6,7/20mm, interval 80mm	Rm.
	A-H12204030.LL11	Omega-profile 122/40/3,0mm, material EN AW 6063.T66, length 6.000mm including elongated hole 11/20mm, interval 80mm	Rm.
	A-H12205622	Omega-profile 122/56/2,2mm, material EN AW 6063.T66, length 6.000mm	Rm.
	A-H12205622.LL	Omega-profile 122/56/2,2mm, material EN AW 6063.T66, length 6.000mm including elongated holes 6,7/20mm, interval 80mm	Rm.
	A-H12205622.LL11	Omega-profile 122/56/2,2mm, material EN AW 6063.T66, length 6.000mm including elongated holes 11/20mm, interval 80mm	Rm.

Product List 2023. Prices in EUR exkl. 20% VAT subject to change without notice.



ALLFACE
Smart Fixing Systems







Flat profiles

Product List 2023. Prices in EUR exkl. 20% VAT subject to change without notice.

Allface Befestigungstechnologie GmbH
www.allface.com

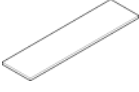
80/176



	PARTNUMBER	DESCRIPTION	UNIT
	A-FL015080	Flat-profile 15/8mm, material EN AW 6060.T66, length 6.000mm	Rm.
	A-FL030030	Flat-profile 30/3mm, material EN AW 6060.T66, length 6.000mm	Rm.
	A-FL040030	Flat-profile 40/3mm, material EN AW 6060.T66, length 6.000mm	Rm.
	A-FL090030	Flat-profile 90/3mm, material EN AW 6060.T66, length 6.000mm	Rm.
	A-FL100040	Flat-profile 100/4mm, material EN AW 6060.T66, length 6.000mm	Rm.
	A-FL150030	Flat-profile 150/3mm, material EN AW 6060.T66, length 6.000mm	Rm.

Product List 2023. Prices in EUR exkl. 20% VAT subject to change without notice.



ALLFACE
Smart Fixing Systems





Joint profiles

Product List 2023. Prices in EUR exkl. 20% VAT subject to change without notice.

Allface Befestigungstechnologie GmbH
www.allface.com

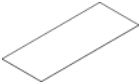
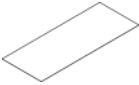
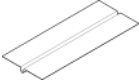
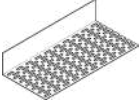
82/176



	PARTNUMBER	DESCRIPTION	UNIT
	P-3325	3325 joint strip, material soft-PVC, length 50m, width: 60mm, packing 100 m/package, colour: black	Rm.
	P-3326	3326 joint strip, material soft-PVC, length 50m, width: 36mm, packing 100 m/package, colour: black	Rm.
	P-9042	9042 vertical joint profile, material aluminium, length 2.500mm, packing 20 pcs./bundle, suitable for 8mm joint, colour: black (allside coated)	Rm.
	P-9044	9044 ventilation profile 30/70, material aluminium, free ventilation cross section 254cm ² /rm, length 2.500mm, packing 20 pcs./bundle, colour: coated black	Rm.
	P-9050	9050 horizontal joint profile for panel thickness 10mm, material aluminium, black coated, length 2.500mm, packing 20 pcs./bundle	Rm.
	P-9061	9061 horizontal joint profile for panel thickness 6mm, material aluminium natural, length 2.500mm, packing 20 pcs./bundle	Rm.
	P-9062	9062 horizontal joint profile for panel thickness 9mm, material aluminium natural, length 2.500mm, packing 20 pcs./bundle	Rm.

Product List 2023. Prices in EUR exkl. 20% VAT subject to change without notice.



	PARTNUMBER	DESCRIPTION	UNIT
	P-9080	9080 Corner profile, material aluminium nature, length 2.500mm, packing 10 pcs./bundle	Rm.
	P-9092	9092 horizontal joint profile for panel thickness 8mm, material aluminium natural, length: 2.500mm, packing 20 pcs./bundle	Rm.
	P-9333	9333 ventilation profile 30/100, material aluminium, free ventilation cross section 393 cm ² /rm, length 2.500mm, packing 10 pcs./bundle, colour: one side coated black	Rm.

Product List 2023. Prices in EUR exkl. 20% VAT subject to change without notice.



ALLFACE
Smart Fixing Systems







Special profiles

Product List 2023. Prices in EUR exkl. 20% VAT subject to change without notice.

Allface Befestigungstechnologie GmbH
www.allface.com

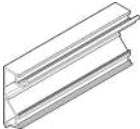

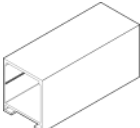
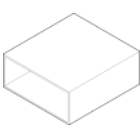
85/176



	PARTNUMBER	DESCRIPTION	UNIT
	A-BAGUETTE.6000	Baguette-Supporting-profile 40/40/1,5mm, material EN AW 6063.T66, length 6.000mm	Rm.
	A-BERSAL.1.6000	Bersal-Starter-profile 70/33/2,0mm, material EN AW 6063.T66, length 6.000mm	Rm.
	A-BERSAL.2.6000	Bersal-top-profile 70/33/2,0mm, material EN AW 6063.T66, length 6.000mm	Rm.
	A-BERSAL.6000	Bersal-Supporting-profile 70/33/2,0mm, material EN AW 6063.T66, length 6.000mm	Rm.
	A-FR07006027	rectangular tube 69,85/60mm, material EN AW 6063.T66, length: 6.000mm	Rm.
	A-FR14006030	rectangular tube 140/60/3,0mm, material EN AW 6063.T66, length 6.000mm	Rm.
	A-H12002825	Omega-profile 120/28/2,5mm, material EN AW 6063.T66, length 6.000mm	Rm.

Product List 2023. Prices in EUR exkl. 20% VAT subject to change without notice.

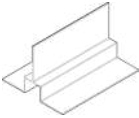
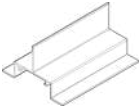

	PARTNUMBER	DESCRIPTION	UNIT
	A-Y08712020	Y-profile 87/120/2,0mm, material EN AW 6063.T66, telorances acc. EN 755-9, length 6.000mm	Rm.
	A-Y12007225	Y-profile 120/72/2,50mm, material EN AW 6063.T66, length 6.000mm	Rm.
	X-T094094.170	T-profile 94/94/2,5mm, material EN AW 6060.T66, length 170mm including helping hand	Pcs.

Product List 2023. Prices in EUR exkl. 20% VAT subject to change without notice.



ALLFACE
Smart Fixing Systems



F1.40 C-hanger system

Product List 2023. Prices in EUR exkl. 20% VAT subject to change without notice.

Allface Befestigungstechnologie GmbH
www.allface.com

88/176

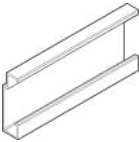
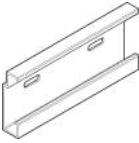
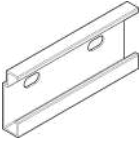
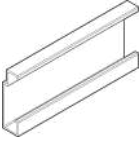
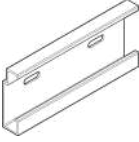

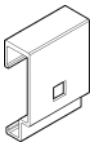
	PARTNUMBER	DESCRIPTION	UNIT
	A-C06602020	C-carrier profile 66/20/2,0mm, material EN AW 6063.T66, length 6.000mm	Rm.
	A-C06602020.LL	C-carrier profile 66/20/2,0mm, material EN AW 6063.T66, length 6.000mm including elongated holes 6,7/20mm, interval 80mm	Rm.
	A-C06602020.LL11	C-carrier profile 66/20/2,0mm, material EN AW 6063.T66, length 6.000mm including elongated holes 11/20mm, interval 80mm	Rm.
	A-C06602020-351	C-carrier profile 66/20/2,0mm, material EN AW 6063.T66, length 6.000mm, anodized E6/C35 (black) 12-15µ	Rm.
	A-C06602020.LL-351	C-carrier profile 66/20/2,0mm, material EN AW 6063.T66, length 6.000mm including elongated holes 6,7/20mm, interval 80mm, anodized E6/C35 (black) 12-15µ	Rm.
	A-C06602020.LL11-351	C-carrier profile 66/20/2,0mm, material EN AW 6063.T66, length 6.000mm including elongated holes 11/20mm, interval 80mm, anodized E6/C35 (black) 12-15µ	Rm.
	A-C06602220.50.10	C-hanger fix from hanger profile 66x22x2,0, length: 50mm, square hole 10,2mm, material EN AW 6063.T66, packing unit: 300 pcs./box	Pcs.

Product List 2023. Prices in EUR exkl. 20% VAT subject to change without notice.

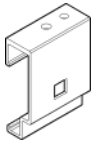
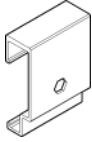
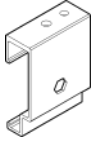
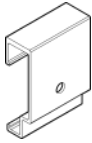
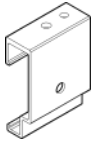
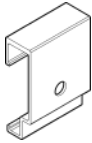

	PARTNUMBER	DESCRIPTION	UNIT
	A-C06602220.50.11	C-hanger adjustable from hanger profile 66/22/2,0, length: 50mm, square hole 10,2mm, thread M6, hole d=5,1mm, material EN AW 6063.T66, packing unit: 300 pcs./box	Pcs.
	A-C06602220.50.20	C-hanger fix from hanger profile 66/22/2,0, length: 50mm, hexagon hole 9,2mm, material EN AW 6063.T66, packing unit: 300 pcs./box	Pcs.
	A-C06602220.50.21	C-hanger adjustable from hanger profile 66/22/2,0, length: 50mm, hexagon hole 9,2mm, thread M6, hole d=5,1mm, material EN AW 6063.T66, packing unit: 300 pcs./box	Pcs.
	A-C06602220.50.30	C-hanger fix from hanger profile 66/22/2,0, length: 50mm, hole 7,0mm, material EN AW 6063.T66, packing unit: 300 pcs./box	Pcs.
	A-C06602220.50.31	C-hanger adjustable from hanger profile 66/22/2,0, length: 50mm, hole 7,0mm, thread M6, hole d=5,1mm, material EN AW 6063.T66, packing unit: 300 pcs./box	Pcs.
	A-C06602220.50.40	C-hanger fix from hanger profile 66/22/2,0, length: 50mm, hole 9,0mm, material EN AW 6063.T66, packing unit: 300 pcs./box	Pcs.

Product List 2023. Prices in EUR exkl. 20% VAT subject to change without notice.

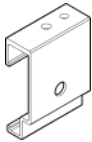
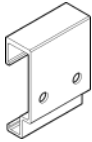
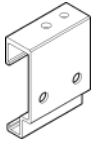
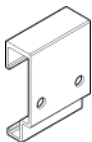
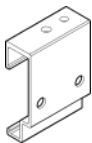
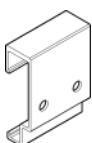

	PARTNUMBER	DESCRIPTION	UNIT
	A-C06602220.50.41	C-hanger adjustable from hanger profile 66/22/2,0, length: 50mm, hole 9,0mm, thread M6, hole d=5,1mm, material EN AW 6063.T66, packing unit: 300 pcs./box	Pcs.
	A-C06602220.50.50	C-hanger fix from hanger profile 66/22/2,0, length: 50mm, 2 holes 7,0mm, distance between holes 28mm, material EN AW 6063.T66, packing unit: 300 pcs./box	Pcs.
	A-C06602220.50.51	C-hanger adjustable from hanger profile 66/22/2,0, length: 50mm, 2 holes 7,0mm, distance between holes 28mm, thread M6, hole d=5,1mm, material EN AW 6063.T66, packing unit: 300 pcs./box	Pcs.
	A-C06602220.50.60	C-hanger fix from hanger profile 66/22/2,0, length: 50mm, 2 holes 7,0mm, distance between holes 32mm, material EN AW 6063.T66, packing unit: 300 pcs./box	Pcs.
	A-C06602220.50.61	C-hanger adjustable from hanger profile 66/22/2,0, length: 50mm, 2 holes 7,0mm, distance between holes 32mm, thread M6, hole d=5,1mm, material EN AW 6063.T66, packing unit: 300 pcs./box	Pcs.
	A-C06602220.50.70	C-hanger fix from hanger profile 66/22/2,0, length: 50mm, 2 holes 5,0mm, distance between holes 22mm, material EN AW 6063.T66, packing unit: 300 pcs./box	Pcs.

Product List 2023. Prices in EUR exkl. 20% VAT subject to change without notice.

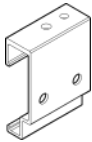
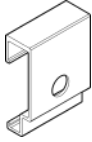
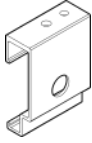
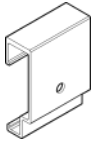
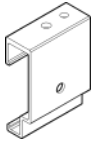
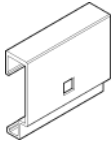

	PARTNUMBER	DESCRIPTION	UNIT
	A-C06602220.50.71	C-hanger adjustable from hanger profile 66/22/2,0, length: 50mm, 2 holes 5,0mm, distance between holes 22mm, thread M6, hole d=5,1mm, material EN AW 6063.T66, packing unit: 300 pcs./box	Pcs.
	A-C06602220.50.72	C-hanger fix from hanger profile 66/22/2,0, length: 50mm, hole 14,2mm centric, material EN AW 6063.T66, packing unit: 300 pcs./box	Pcs.
	A-C06602220.50.73	C-hanger adjustable from hanger profile 66/22/2,0, length: 50mm, hole 14,2mm centric, thread M6, hole d=5,1mm, material EN AW 6063.T66, packing unit: 300 pcs./box	Pcs.
	A-C06602220.50.80	C-hanger fix from hanger profile 66/22/2,0, length: 50mm, hole 6,5mm, material EN AW 6063.T66, packing unit: 300 pcs./box	Pcs.
	A-C06602220.50.81	C-hanger adjustable from hanger profile 66/22/2,0, length: 50mm, hole 6,5mm, thread M6, hole d=5,1mm, material EN AW 6063.T66, packing unit: 300 pcs./box	Pcs.
	A-C06602220.80.10	C-hanger fix from hanger profile 66/22/2,0, length: 80mm, square hole 10,2mm centric, material: EN AW 6063.T66, packing unit: 200 pcs./box	Pcs.

Product List 2023. Prices in EUR exkl. 20% VAT subject to change without notice.

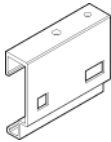
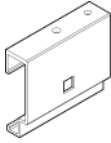
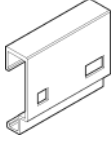
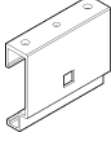
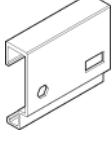
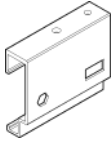

	PARTNUMBER	DESCRIPTION	UNIT
	A-C06602220.80.11	C-hanger adjustable from hanger profile 66/22/2,0, length: 80mm, square hole 10,2mm + elongated hole 10,2x16,2mm, thread M6, hole d=5,1mm, material: EN AW 6063.T66, packing unit: 200 pcs./box	Pcs.
	A-C06602220.80.12	C-hanger adjustable from hanger profile 66/22/2,0, length: 80mm, square hole 10,2mm centic, thread M6, hole d=5,1mm, material: EN AW 6063.T66, packing unit: 200 pcs./box	Pcs.
	A-C06602220.80.13	C-hanger fix from hanger profile 66/22/2,0, length: 80mm, square hole 10,2mm + elongated hole 10,2x16,2mm, material: EN AW 6063.T66, packing unit: 200 pcs./box	Pcs.
	A-C06602220.80.14	C-hanger adjustable from hanger profile 66/22/2,0, length: 80mm, square hole 10,2mm centic, 2x thread M6, 1x hole d=5,1mm, material: EN AW 6063.T66, packing unit: 200 pcs./box	Pcs.
	A-C06602220.80.20	C-hanger fix from hanger profile 66/22/2,0, length: 80mm, hexagon hole 9,2mm centric, material EN AW 6063.T66, packing unit: 200 pcs./box	Pcs.
	A-C06602220.80.21	C-hanger adjustable from hanger profile 66/22/2,0, length: 80mm, hexagon hole 9,2mm + elongated hole 16,2x9,2mm, thread M6, hole d=5,1mm, material EN AW 6063.T66, packing unit: 200 pcs./box	Pcs.

Product List 2023. Prices in EUR exkl. 20% VAT subject to change without notice.

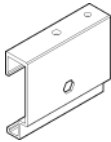
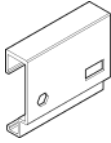
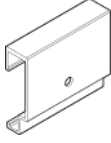
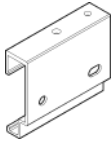
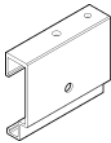
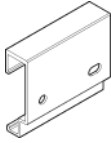

	PARTNUMBER	DESCRIPTION	UNIT
	A-C06602220.80.22	C-hanger adjustable from hanger profile 66/22/2,0, length: 80mm, hexagon hole 9,2mm centric, thread M6, hole d=5,1mm, material EN AW 6063.T66, packing unit: 200 pcs./box	Pcs.
	A-C06602220.80.23	C-hanger fix from hanger profile 66/22/2,0, length: 80mm, hexagon hole 9,2mm + elongated hole 16,2x9,2mm, thread M6, hole d=5,1mm, material EN AW 6063.T66, packing unit: 200 pcs./box	Pcs.
	A-C06602220.80.30	C-hanger fix from hanger profile 66/22/2,0, length: 80mm, hole 7,0mm centric, material EN AW 6063.T66, packing unit: 200 pcs./box	Pcs.
	A-C06602220.80.31	C-hanger adjustable from hanger profile 66/22/2,0, length: 80mm, hole 7,0mm + elongated hole 7,0x12,0mm, e=50mm, thread M6, hole d=5,1mm, material EN AW 6063.T66, packing unit: 200 pcs./box	Pcs.
	A-C06602220.80.32	C-hanger adjustable from hanger profile 66/22/2,0, length: 80mm, hole 7,0mm centric, thread M6, hole d=5,1mm, material EN AW 6063.T66, packing unit: 200 pcs./box	Pcs.
	A-C06602220.80.33	C-hanger fix from hanger profile 66/22/2,0, length: 80mm, hole 7,0mm + elongated hole 7,0x12,0mm, e=50mm, material EN AW 6063.T66, packing unit: 200 pcs./box	Pcs.

Product List 2023. Prices in EUR exkl. 20% VAT subject to change without notice.

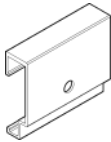
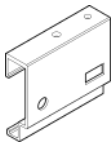
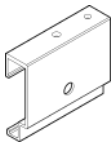
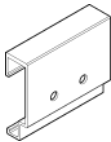
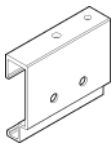
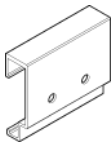

	PARTNUMBER	DESCRIPTION	UNIT
	A-C06602220.80.40	C-hanger fix from hanger profile 66/22/2,0, length: 80mm, hole 9,0mm centric, material EN AW 6063.T66, packing unit: 200 pcs./box	Pcs.
	A-C06602220.80.41	C-hanger adjustable from hanger profile 66/22/2,0, length: 80mm, hole 9,0mm + elongated hole 9,2x16,2mm, thread M6, hole d=5,1mm, material EN AW 6063.T66, packing unit: 200 pcs./box	Pcs.
	A-C06602220.80.42	C-hanger adjustable from hanger profile 66/22/2,0, length: 80mm, hole 9,0mm centric, thread M6, hole d=5,1mm, material EN AW 6063.T66, packing unit: 200 pcs./box	Pcs.
	A-C06602220.80.50	C-hanger fix from hanger profile 66/22/2,0, length: 80mm, 2 holes á 7,0mm, distance between hole 28mm, material EN AW 6063.T66, packing unit: 200 pcs./box	Pcs.
	A-C06602220.80.51	C-hanger adjustable from hanger profile 66/22/2,0, length: 80mm, 2 holes á 7,0mm, distance between holes 28mm, thread M6, hole d=5,1mm, material EN AW 6063.T66, packing unit: 200 pcs./box	Pcs.
	A-C06602220.80.60	C-hanger fix from hanger profile 66/22/2,0, length: 80mm, 2 holes á 7,0mm, distance between hole 32mm, material EN AW 6063.T66, packing unit: 200 pcs./box	Pcs.



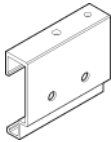
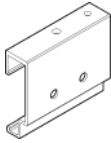
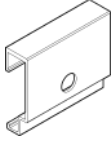
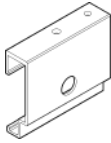
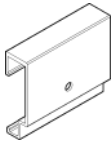

Product List 2023. Prices in EUR exkl. 20% VAT subject to change without notice.



	PARTNUMBER	DESCRIPTION	UNIT
	A-C06602220.80.61	C-hanger adjustable from hanger profile 66/22/2,0, length: 80mm, 2 holes á 7,0mm, e=32mm, thread M6, hole d=5,1mm, material EN AW 6063.T66, packing unit: 200 pcs./box	Pcs.
	A-C06602220.80.70	C-hanger fix from hanger profile 66/22/2,0, length: 80mm, 2 holes 5,0mm, distance between holes 22mm material EN AW 6063.T66, packing unit: 300 pcs./box	Pcs.
	A-C06602220.80.71	C-hanger adjustable from hanger profile 66/22/2,0, length: 80mm, 2 holes 5,0mm, distance between holes 22mm, thread M6, hole d=5,1mm, material EN AW 6063.T66, packing unit: 300 pcs./box	Pcs.
	A-C06602220.80.72	C-hanger fix from hanger profile 66/22/2,0, length: 80mm, hole 14,2mm centric, material EN AW 6063.T66, packing unit: 200 pcs./box	Pcs.
	A-C06602220.80.73	C-hanger adjustable from hanger profile 66/22/2,0, length: 80mm, hole 14,2mm centric, thread M6, hole d=5,1mm, material EN AW 6063.T66, packing unit: 200 pcs./box	Pcs.
	A-C06602220.80.80	C-hanger fix from hanger profile 66/22/2,0, length: 80mm, hole 6,5mm centric, material EN AW 6063.T66, packing unit: 200 pcs./box	Pcs.

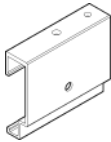

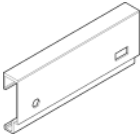
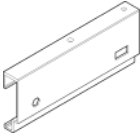
Product List 2023. Prices in EUR exkl. 20% VAT subject to change without notice.

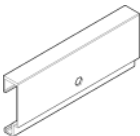

	PARTNUMBER	DESCRIPTION	UNIT
	A-C06602220.80.81	C-hanger adjustable from hanger profile 66/22/2,0, length: 80mm, hole 6,5mm centric, thread M6, hole d=5,1mm, material EN AW 6063.T66, packing unit: 200 pcs./box	Pcs.
	A-C06602220.170.11	C-hanger adjustable from hanger profile 66/22/2,0, length: 170mm, square hole 10,2mm + elongated hole 10,2x16,2mm, thread M6, hole d=5,1mm, material EN AW 6063.T66	Pcs.
	A-C06602220.170.20	C-hanger fix from hanger profile 66/22/2,0, length: 170mm, hexagon hole 9,2mm + elongated hole 18x9,2mm, material EN AW 6063.T66	Pcs.
	A-C06602220.170.21	C-hanger adjustable from hanger profile 66/22/2,0, length: 170mm, hexagon hole 9,2mm + elongated hole 18x9,2mm, hole distance 120mm, thread M6, hole d=5,1mm, material EN AW 6063.T66	Pcs.
	A-C06602220.170.22	C-hanger adjustable from hanger profile 66/22/2,0, length: 170mm, hexagon hole 9,2mm centric, thread M6, hole d=5,1mm, material EN AW 6063.T66	Pcs.
	A-C06602220.170.23	C-hanger fix from hanger profile 66/22/2,0, length: 170mm, hexagon hole 9,2mm centric, material EN AW 6063.T66	Pcs.

Product List 2023. Prices in EUR exkl. 20% VAT subject to change without notice.

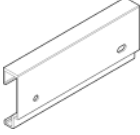
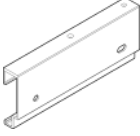
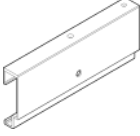

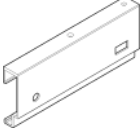
	PARTNUMBER	DESCRIPTION	UNIT
	A-C06602220.170.24	C-hanger adjustable from hanger profile 66/22/2,0, length: 170mm, hexagon hole 9,2mm centric, 2 threads M6, hole d=5,1mm, material EN AW 6063.T66	Pcs.
	A-C06602220.170.30	C-hanger fix from hanger profile 66/22/2,0, length: 170mm, hole 7,0mm + elongated hole 7x18mm, material EN AW 6063.T66	Pcs.
	A-C06602220.170.31	C-hanger adjustable from hanger profile 66/22/2,0, length: 170mm, hole 7mm + elongated hole 7x18mm, e=120mm, thread M6, hole d=5,1mm, material EN AW 6063.T66	Pcs.
	A-C06602220.170.32	C-hanger adjustable from hanger profile 66/22/2,0, length: 170mm, hole 7,0mm centric, thread M6, hole d=5,1mm, material EN AW 6063.T66	Pcs.
	A-C06602220.170.40	C-hanger fix from hanger profile 66/22/2,0, length: 170mm, hole 9,0mm + elongated hole 9x18mm, material EN AW 6063.T66	Pcs.
	A-C06602220.170.41	C-hanger adjustable from hanger profile 66/22/2,0, length: 170mm, hole 9,0mm + elongated hole 9,2x16,2mm, thread M6, hole d=5,1mm, material EN AW 6063.T66, packing unit: 150 pcs./box	Pcs.

Product List 2023. Prices in EUR exkl. 20% VAT subject to change without notice.

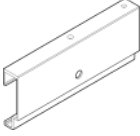
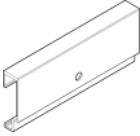
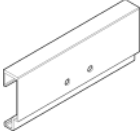
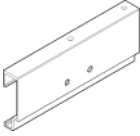

	PARTNUMBER	DESCRIPTION	UNIT
	A-C06602220.170.42	C-hanger adjustable from hanger profile 66/22/2,0, length: 170mm, hole 9,0mm centric, thread M6, hole d=5,1mm, material EN AW 6063.T66, packing unit: 150 pcs./box	Pcs.
	A-C06602220.170.43	C-hanger adjustable from hanger profile 66/22/2,0, length: 170mm, hole 9,0mm centric, material EN AW 6063.T66, packing unit: 150 pcs./box	Pcs.
	A-C06602220.170.60	C-hanger fix from hanger profile 66/22/2,0, length: 170mm, 2 holes 7,0mm, distance betweenholes 32mm, thread M6, hole d=5,1mm, material EN AW 6063.T66	Pcs.
	A-C06602220.170.61	C-hanger adjustable from hanger profile 66/22/2,0, length: 170mm, 2 holes 7,0mm, distance betweenholes 32mm, thread M6, hole d=5,1mm, material EN AW 6063.T66	Pcs.

Product List 2023. Prices in EUR exkl. 20% VAT subject to change without notice.



ALLFACE
Smart Fixing Systems





F1.41 C-hanger system

Product List 2023. Prices in EUR exkl. 20% VAT subject to change without notice.

Allface Befestigungstechnologie GmbH
www.allface.com





100/176



	PARTNUMBER	DESCRIPTION	UNIT
	A-C08402520	C-carrier profile (F1.41) 84/25/2,0mm, material EN AW 6063.T66, length 6.000mm	Rm.
	A-C08402520.LL	C-carrier profile (F1.41) 84/25/2,0mm, material EN AW 6063.T66, length 6.000mm including elongated holes 6,7/20mm, interval 80mm	Rm.
	A-C08402520.LL11	C-carrier profile (F1.41) 84/25/2,0mm, material EN AW 6063.T66, length 6.000mm including elongated holes 11/20mm, interval 80mm	Rm.
	A-C08402520-351	C-carrier profile (F1.41) 84/25/2,0mm, material EN AW 6063.T66, length 6.000mm, anodized E6/C35 (black) 12-15µ	Rm.
	A-C08402520.LL-351	C-carrier profile (F1.41) 84/25/2,0mm, material EN AW 6063.T66, length 6.000mm including elongated holes 6,7/20mm, interval 80mm, anodized E6/C35 (black) 12- 15µ	Rm.
	A-C08502230.50.30	C-hanger fix from hanger profile (F1.41) 85/22/3,0, length: 50mm, hole 7,0mm centric, material EN AW 6063.T66	Pcs.

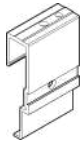
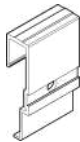

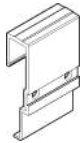
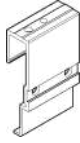

Product List 2023. Prices in EUR exkl. 20% VAT subject to change without notice.



	PARTNUMBER	DESCRIPTION	UNIT
	A-C08502230.50.31	C-hanger adjustable from hanger profile (F1.41) 85/22/3,0, length: 50mm, hole 7,0mm centric, thread M6, hole d=5,1mm, material EN AW 6063.T66	Pcs.
	A-C08502230.50.40	C-hanger fix from hanger profile (F1.41) 85/22/3,0, length: 50mm, hole 9,0mm, material EN AW 6063.T66	Pcs.
	A-C08502230.50.42	C-hanger adjustable from hanger profile (F1.41) 85/22/3,0, length: 50mm, hole 9,0mm centric, thread M6, hole d=5,1mm, material EN AW 6063.T66	Pcs.
	A-C08502230.50.60	C-hanger fix from hanger profile (F1.41) 85/22/3,0, length: 50mm, 2 holes 7,0mm, distance between holes 32mm material EN AW 6063.T66	Pcs.
	A-C08502230.50.61	C-hanger adjustable from hanger profile (F1.41) 85/22/3,0, length: 50mm, 2 holes 7,0mm, distance between holes 32mm, thread M6, hole d=5,1mm, material EN AW 6063.T66	Pcs.
	A-C08502230.80.30	C-hanger fix from hanger profile (F1.41) 85/22/3,0, length: 80mm, hole 7,0mm centric, material EN AW 6063.T66	Pcs.

Product List 2023. Prices in EUR exkl. 20% VAT subject to change without notice.



	PARTNUMBER	DESCRIPTION	UNIT
	A-C08502230.80.31	C-hanger adjustable from hanger profile (F1.41) 85/22/3,0, length: 80mm, hole 7,0mm + elongated hole 7,0x18,0mm, e=50mm, thread M6, hole d=5,1mm, material EN AW 6063.T66	Pcs.
	A-C08502230.80.32	C-hanger adjustable from hanger profile (F1.41) 85/22/3,0, length: 80mm, hole 7,0mm centric, thread M6, hole d=5,1mm, material EN AW 6063.T66	Pcs.
	A-C08502230.80.33	C-hanger fix from hanger profile (F1.41) 85/22/3,0, length: 80mm, hole 7,0mm + elongated hole 7,0x18mm, e=50mm, material EN AW 6063.T66	Pcs.
	A-C08502230.80.40	C-hanger fix from hanger profile (F1.41) 85/22/3,0, length: 80mm, hole 9,0mm centric, material EN AW 6063.T66	Pcs.
	A-C08502230.80.42	C-hanger adjustable from hanger profile (F1.41) 85/22/3,0, length: 80mm, hole 9,0mm centric, thread M6, hole d=5,1mm, material EN AW 6063.T66	Pcs.

Product List 2023. Prices in EUR exkl. 20% VAT subject to change without notice.



ALLFACE
Smart Fixing Systems







F1.44 C-hanger system

Product List 2023. Prices in EUR exkl. 20% VAT subject to change without notice.

Allface Befestigungstechnologie GmbH
www.allface.com





104/176



	PARTNUMBER	DESCRIPTION	UNIT
	A-C08403220	C-carrier profile (F1.44) 84/32/2,0mm, material EN AW 6063 T66, length 6.000mm	Rm.
	A-C08403220.LL	C-carrier profile (F1.44) 84/32/2,0mm, material EN AW 6063 T66, length 6.000mm including elongated holes 6,7/20mm, interval 80mm	Rm.
	A-C08403220.LL11	C-carrier profile (F1.44) 84/32/2,0mm, material EN AW 6063 T66, length 6.000mm including elongated holes 11/20mm, interval 80mm	Rm.
	A-AJ-F1.44.50.30	C-hanger fix from j-hanger profile (F1.44) 81,25/16,7mm, length: 50mm, hole 7,0mm centric, material EN AW 6063.T66, incl. 1xNeopren Norton V530 15x3mm	Pcs.
	A-AJ-F1.44.50.31	C-hanger adjustable from j-hanger profile (F1.44) 81,25/16,7mm, length: 50mm, hole 7mm centric, thread M6, hole d=7,0mm, material EN AW 6063 T66, incl. 1xNeopren Norton V530 15x3mm	Pcs.
	A-AH-F1.44.50.30	C-hanger fix from h-hanger profile (F1.44) 71/18,4mm, length: 50mm, hole 7,0mm, material EN AW 6063.T66 packing unit: 150 pcs./box, incl. 1xNeopren Norton V530 15x3mm	Pcs.

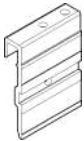
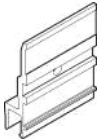



Product List 2023. Prices in EUR exkl. 20% VAT subject to change without notice.



	PARTNUMBER	DESCRIPTION	UNIT
	A-AJ-F1.44.60.30	C-hanger fix from j-hanger profile (F1.44) 81,25/16,7mm, length: 60mm, hole 7,0mm centric, material EN AW 6063 T66, incl. 1xNeopren Norton V530 15x3mm	Pcs.
	A-AJ-F1.44.60.31	C-hanger adjustable from j-hanger profile (F1.44) 81,25/16,7mm, length: 60mm, hole 7mm centric, thread M6, hole d=7,0mm, material EN AW 6063 T66, incl. 1xNeopren Norton V530 15x3mm	Pcs.
	A-AH-F1.44.60.30	C-hanger fix from h-hanger profile (F1.44) 71/18,4mm, length: 60mm, hole 7,0mm, material EN AW 6063.T66 packing unit: 150 pcs./box, incl. 1xNeopren Norton V530 15x3mm	Pcs.
	A-AJ-F1.44.120.30	C-hanger fix from j-hanger profile (F1.44) 81,25/16,7mm, length: 120mm, hole 7,0mm centric, material EN AW 6063.T66, incl. 1xNeopren Norton V530 15x3mm	Pcs.
	A-AJ-F1.44.120.31	C-hanger adjustable from j-hanger profile (F1.44) 81,25/16,7mm, length: 120mm, hole 7mm centric, thread M6, hole d=7,0mm, material EN AW 6063.T66, incl. 1xNeopren Norton V530 15x3mm	Pcs.
	A-AJ-F1.44.120.32	C-hanger adjustable from j-hanger profile (F1.44) 81,25/16,7mm, length: 120mm, hole 7mm + elongated hole 7,0x18mm, e=80mm, thread M6, hole d=7,0mm, material EN AW 6063.T66, incl. 1xNeopren Norton V530 15x3mm	Pcs.

Product List 2023. Prices in EUR exkl. 20% VAT subject to change without notice.



	PARTNUMBER	DESCRIPTION	UNIT
	A-AJ-F1.44.120.33	C-hanger fix from j-hanger profile (F1.44) 81,25/16,7mm, length: 120mm, hole 7,0mm + elongated hole 7,0x18mm, e=80mm, material EN AW 6063.T66, incl. 1xNeopren Norton V530 15x3mm	Pcs.
	A-AJ-F1.44.120.34	C-hanger adjustable from j-hanger profile (F1.44) 81,25/16,7mm, length: 120mm, hole 7mm + elongated hole 7,0x18mm, e=80mm, 2x thread M6, hole d=7,0mm, material EN AW 6063.T66, incl. 1xNeopren Norton V530 15x3mm	Pcs.
	A-AH-F1.44.120.30	C-hanger fix from h-hanger profile (F1.44) 71/18,4mm, length: 120mm, hole 7,0mm, material EN AW 6063.T66 packing unit: 150 pcs./box, incl. 1xNeopren Norton V530 15x3mm	Pcs.
	A-AH-F1.44.120.32	C-hanger fix from h-hanger profile (F1.44) 71/18,4mm, length: 120mm, hole 7,0mm + elongated hole 7,0x18mm, e=80mm, material EN AW 6063.T66 packing unit: 150 pcs./box, incl. 1xNeopren Norton V530 15x3mm	Pcs.

Product List 2023. Prices in EUR exkl. 20% VAT subject to change without notice.



ALLFACE
Smart Fixing Systems





F1.50/F2.50 Cassette system

Product List 2023. Prices in EUR exkl. 20% VAT subject to change without notice.

Allface Befestigungstechnologie GmbH
www.allface.com

108/176

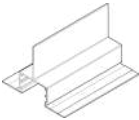
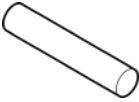

	PARTNUMBER	DESCRIPTION	UNIT
	A-H09003520	Cassette-profile 90/35/2,0mm, material EN AW 6063.T66, length 6.000mm	Rm.
	A-H09003520.LL	Cassette-profile 90/35/2,0mm, material EN AW 6063.T66, length 6.000mm including elongated holes 6,7/20mm, interval 80mm	Rm.
	A-Y09312620	Y-profile 93/126/2,0mm (F1.50), material EN AW 6063.T66, length 6.000mm	Rm.
	A-B010.52	aluminium bolt 10mm, material EN AW 6060.T66, length 52mm	Pcs.
	K-L02203416.40	clip for cassette profile 22/34/1,6mm, material EN AW 6063.T66, length 40mm, 1 hole á 4,1mm	Pcs.

Product List 2023. Prices in EUR exkl. 20% VAT subject to change without notice.



ALLFACE
Smart Fixing Systems

F1.59/F1.59i/F2.59/F2.59i

Cassette system

Product List 2023. Prices in EUR exkl. 20% VAT subject to change without notice.

Allface Befestigungstechnologie GmbH
www.allface.com

110/176



	PARTNUMBER	DESCRIPTION	UNIT
	A-H09703020	Omega-profile (F2.59i) 97/30/2,0mm, material EN AW 6063.T66, length 6.000mm	Rm.
	A-H09703020.LL	Omega-profile (F2.59i) 97/30/2,0mm, material EN AW 6063.T66, length 6.000mm including elongated holes 6,7/20mm, interval 80mm	Rm.
	A-H09703020.LL11	Omega-profile (F2.59i) 97/30/2,0mm, material EN AW 6063.T66, length 6.000mm including elongated holes 11/20mm, interval 80mm	Rm.
	A-H09703020-351	Omega-profile (F2.59i) 97/30/2,0mm, material EN AW 6063.T66, length 6.000mm, anodized E6/C35 (black) 12-15µ	Rm.
	A-H09703020.LL-351	Omega-profile (F2.59i) 97/30/2,0mm, material EN AW 6063.T66, length 6.000mm including elongated holes 6,7/20mm, interval 80mm, anodized E6/C35 (black) 12- 15µ	Rm.
	A-H09703020.LL11-351	Omega-profile (F2.59i) 97/30/2,0mm, material EN AW 6063.T66, length 6.000mm including elongated holes 11/20mm, interval 80mm, anodized E6/C35 (black) 12- 15µ	Rm.

Product List 2023. Prices in EUR exkl. 20% VAT subject to change without notice.

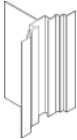
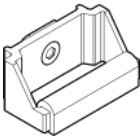
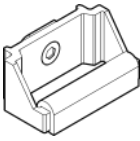
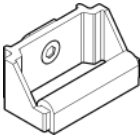
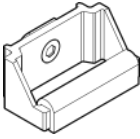
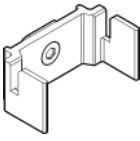

	PARTNUMBER	DESCRIPTION	UNIT
	A-Y09707920	Y-profile (F1.59/F1.59i) 97/79/2,0mm, material EN AW 6063.T66, length 6.000mm	Rm.
	A-B06203160	bolt clip (F1.59/F2.59), material EN AW 6060.T66, width 62mm, depth 31mm with guide channel including neoprene, slide nut and countersunk screw	Pcs.
	A-B06203160.9003	bolt clip (F1.59/F2.59), material EN AW 6060.T66, width 62mm, depth 31mm with guide channel including neoprene, slide nut and countersunk screw, RAL 9003	Pcs.
	A-B06203160.9005	bolt clip (F1.59/F2.59), material EN AW 6060.T66, width 62mm, depth 31mm with guide channel including neoprene, slide nut and countersunk screw, RAL 9005	Pcs.
	A-B06203160.9006	bolt clip (F1.59/F2.59), material EN AW 6060.T66, width 62mm, depth 31mm with guide channel including neoprene, slide nut and countersunk screw, RAL 9006	Pcs.
	A-B06203160.I	bolt clip (F1.59i/F2.59i), material EN AW 6060.T66, width 62mm, depth 31mm with guide channel including slide nut and countersunk screw	Pcs.

Product List 2023. Prices in EUR exkl. 20% VAT subject to change without notice.

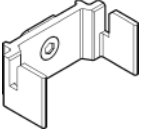
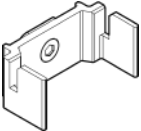
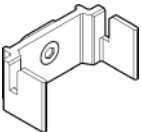

	PARTNUMBER	DESCRIPTION	UNIT
	A-B06203160.I.9003	bolt clip (F1.59i/F2.59i), material EN AW 6060.T66, width 62mm, depth 31mm with guide channel including slide nut and countersunk screw, RAL 9003	Pcs.
	A-B06203160.I.9005	bolt clip (F1.59i/F2.59i), material EN AW 6060.T66, width 62mm, depth 31mm with guide channel including slide nut and countersunk screw, RAL 9005	Pcs.
	A-B06203160.I.9006	bolt clip (F1.59i/F2.59i), material EN AW 6060.T66, width 62mm, depth 31mm with guide channel including slide nut and countersunk screw, RAL 9006	Pcs.

Product List 2023. Prices in EUR exkl. 20% VAT subject to change without notice.



ALLFACE
Smart Fixing Systems

SZ20 Cassette system

Product List 2023. Prices in EUR exkl. 20% VAT subject to change without notice.

Allface Befestigungstechnologie GmbH
www.allface.com

114/176



	PARTNUMBER	DESCRIPTION	UNIT
	A-ACH960500	Omega-profile for cassette-system (35953), material EN AW 6063.T66, length 6.000mm	Rm.
	A-ACB400500	Base-profile for cassette-system (44026), material EN AW 6063 T66, length 6.000mm	Rm.
	A-ACS398345	S-profile for cassette-system (44024), material EN AW 6063.T66, length 6.000mm	Rm.
	A-ACZ485460	Z-profile for cassette-system (44025), material EN AW 6063.T66, length 6.000mm	Rm.
	Z-M02061	Plastic Clip SZ 20, length 40mm, 100 pcs./box	Pcs.

Product List 2023. Prices in EUR exkl. 20% VAT subject to change without notice.



ALLFACE
Smart Fixing Systems

F1.23/F1.24

Product List 2023. Prices in EUR exkl. 20% VAT subject to change without notice.

Allface Befestigungstechnologie GmbH
www.allface.com

116/176



	PARTNUMBER	DESCRIPTION	UNIT
	A-K05403025.S	clamp-profile "Bottom/Top" 54/30/2,0mm, material EN AW 6063.T66, length 6.000mm	Rm.
	A-K05403025.S.LL	clamp-profile "Bottom/Top" 54/30/2,0mm, material EN AW 6063.T66, length 6.000mm including elongated holes	Rm.
	A-K05403025.S-351	clamp-profile "Bottom/Top" 54/30/2,0mm, material EN AW 6063.T66, length 6.000mm, anodized E6/C35 (black) 12-15µ	Rm.
	A-K05403025.S.LL-351	clamp-profile "Bottom/Top" 54/30/2,0mm, material EN AW 6063.T66, length 6.000mm including elongated holes, anodized E6/C35 (black) 12-15µ	Rm.
	A-K05403025.M	clamp-profile "T" 54/30/2,0mm, material EN AW 6063.T66, length 6.000mm	Rm.
	A-K05403025.M.LL	clamp-profile "T" 54/30/2,0mm, material EN AW 6063.T66, length 6.000mm including elongated holes	Rm.
	A-K05403025.M-351	clamp-profile "T" 54/30/2,0mm, material EN AW 6063.T66, length 6.000mm, anodized E6/C35 (black) 12-15µ	Rm.

Product List 2023. Prices in EUR exkl. 20% VAT subject to change without notice.



	PARTNUMBER	DESCRIPTION	UNIT
	A-K05403025.M.LL-351	clamp-profile "T" 54/30/2,0mm, material EN AW 6063.T66, length 6.000mm, including elongated holes, anodized E6/C35 (black) 12-15µ	Rm.
	A-K05003025	clamp-profile "U/0" 50/30/2,5mm, (F1.23/F1.24 bottom/top), material EN AW 6063.T66, length 6.000mm	Rm.
	A-K05003025.LL	clamp-profile "U/0" 50/30/2,5mm, (F1.23/F1.24 bottom/top), material EN AW 6063.T66, length 6.000mm including elongated holes 6,7/20mm, interval 80mm	Rm.
	A-K05003025.100.1	clamp "U/0" 50/30/2,5mm, (F1.23/F1.24 bottom/top), material EN AW 6063.T66, length 100mm, incl. 2 fixing holes	Pcs.
	A-K04803025	clamp-profile "T" 48/30/2,5mm, (F1.23/F1.24 standard), material EN AW 6063.T66, length 6.000mm	Rm.
	A-K04803025.LL	clamp-profile "T" 48/30/2,5mm, (F1.23/F1.24 standard), material EN AW 6063.T66, length 6.000mm including elongated holes 6,7/20mm, interval 80mm	Rm.
	A-K04803025.100.1	clamp "T" 48/30/2,5mm, (F1.23/F1.24 standard), material EN AW 6063.T66, length 100mm, incl. 2 fixing holes	Pcs.

Product List 2023. Prices in EUR exkl. 20% VAT subject to change without notice.



ALLFACE
Smart Fixing Systems





F1.29 Terracotta system

Product List 2023. Prices in EUR exkl. 20% VAT subject to change without notice.

Allface Befestigungstechnologie GmbH
www.allface.com

119/176

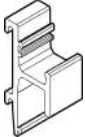
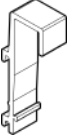
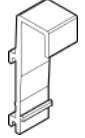

	PARTNUMBER	DESCRIPTION	UNIT
	A-TCR0580255	Carrier profile for terra cotta system (F1.29), material EN AW 6063.T66, length 6.000mm	Rm.
	A-TCR0580255.LL	Carrier profile for terra cotta system (F1.29), material EN AW 6063 T66, length 6.000mm including 2x elongated holes 6,7/20mm, interval 80mm	Rm.
	A-TCB0714325.16	Bottom-clip for terra cotta system (F1.29), material EN AW 6063.T66, length 16mm	Pcs.
	A-TCB0714325.20	Bottom-clip for terra cotta system (F1.29), material EN AW 6063.T66, length 20mm	Pcs.
	A-TCS0600285.20	Standard-clip for terra cotta system (F1.29), material EN AW 6063.T66, length 20mm	Pcs.
	A-TCT0730280.16	Top-clip for terra cotta system (F1.29), material EN AW 6063.T66, length 16mm	Pcs.
	A-TCT0730280.20	Top-clip for terra cotta system (F1.29), material EN AW 6063.T66, length 20mm	Pcs.

Product List 2023. Prices in EUR exkl. 20% VAT subject to change without notice.



	PARTNUMBER	DESCRIPTION	UNIT
	Z-P4064.16	Silicone gasket P4064, length: 16mm, colour: black, 65 +/-5 Shore	Pcs.
	Z-P4064.20	Silicone gasket P4064, length: 20mm, colour: black, 65 +/-5 Shore	Pcs.
	Z-P4126.16	Silicone gasket P4126, length: 16mm, colour: black, 65 +/-5 Shore	Pcs.
	Z-P4126.20	Silicone gasket P4126, length: 20mm, colour: black, 65 +/-5 Shore	Pcs.

Product List 2023. Prices in EUR exkl. 20% VAT subject to change without notice.



ALLFACE
Smart Fixing Systems



F3.33

Product List 2023. Prices in EUR exkl. 20% VAT subject to change without notice.

Allface Befestigungstechnologie GmbH
www.allface.com



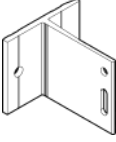
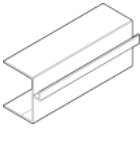
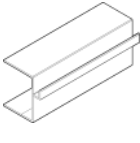

122/176

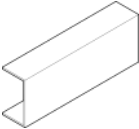

	PARTNUMBER	DESCRIPTION	UNIT
	F3.060.060.90D6,5	bracket F3.060.060.90D6,5, material EN AW 6063.T66, 2 fixing holes 22/6,5mm, height 90mm, depth 60mm, opening space 60mm	Pcs.
	F3.060.060.90R6,5	bracket F3.060.060.90R6,5, material EN AW 6063.T66, 1 round hole á 6,5mm, height 90mm, depth 60mm, opening space 60mm	Pcs.
	F3.060.060.50R6,5X3	bracket F3.060.060.50R6,5X3, material EN AW 6063.T66, 1 round hole á 6,5mm + 2 elongated holes 22/6,5mm, height 50mm, depth 60mm, opening space 60mm, 1 elongated hole 18/5,2mm + 1 round hole 5,2mm	Pcs.
	F3.060.060.50R6,5X2	bracket F3.060.060.50R6,5X2, material EN AW 6063.T66, 1 round hole á 6,5mm + 1 elongated holes 22/6,5mm, height 50mm, depth 60mm, 1 elongated hole 18/5,2mm + 1 round hole 5,2mm	Pcs.
	A-U06005622	U-profile (F3.33) 60/56/2,2mm, material EN AW 6063.T66, length 6.000mm	Rm.
	A-U06005622-351	U-profile (F3.33) 60/56/2,2mm, material EN AW 6063.T66, length 6.000mm, anodized E6/C35 (black) 12-15µ	Rm.

Product List 2023. Prices in EUR exkl. 20% VAT subject to change without notice.



	PARTNUMBER	DESCRIPTION	UNIT
	A-C05403020	C-profile (F3.33) 54,6/30/2,0mm, material EN AW 6063.T66, length 6.000mm	Rm.
	A-H06403225	Omega-profile (F3.33) 64/32/2,5mm, material EN AW 6063.T66, length 6.000mm	Rm.
	A-H06403225-351	Omega-profile (F3.33) 64/32/2,5mm, material EN AW 6063.T66, length 6.000mm, anodized E6/C35 (black) 12-15µ	Rm.
	A-I080008005.35	insert profile (F3.33) 80/8/5mm, material EN AW 6063.T66, length 35,6mm, 2 holes á 5,2mm	Pcs.

Product List 2023. Prices in EUR exkl. 20% VAT subject to change without notice.



ALLFACE
Smart Fixing Systems







TS 300

Product List 2023. Prices in EUR exkl. 20% VAT subject to change without notice.

Allface Befestigungstechnologie GmbH
www.allface.com

125/176



	PARTNUMBER	DESCRIPTION	UNIT
	A-TS300AP	TS300 Starter-profile, material EN AW 6063, length 6.000mm	Rm.
	A-TS300AP.LL	TS300 Starter-profile, material EN AW 6063, length 6.000mm including elongated holes 6,7/20mm, interval 80mm	Rm.
	A-TS300AP.LL11	TS300 Starter-profile, material EN AW 6063, length 6.000mm including elongated holes 11/20mm, interval 80mm	Rm.
	A-TS300HP	TS300 Main-profile, material EN AW 6063, length 6.000mm including Neopren tape norton V540 6x9 (dxb)	Rm.
	A-TS300HP.LL	TS300 Main-profile, material EN AW 6063, length 6.000mm including elongated holes 6,7/20mm, interval 80mm, including Neopren tape norton V540 6x9 (dxb)	Rm.
	A-TS300HP.LL11	TS300 Main-profile, material EN AW 6063, length 6.000mm including elongated holes 11/20mm, interval 80mm, including Neopren tape norton V540 6x9 (dxb)	Rm.

Product List 2023. Prices in EUR exkl. 20% VAT subject to change without notice.



ALLFACE
Smart Fixing Systems





ME01

Product List 2023. Prices in EUR exkl. 20% VAT subject to change without notice.

Allface Befestigungstechnologie GmbH
www.allface.com

127/176

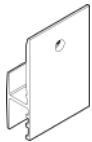
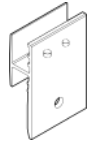
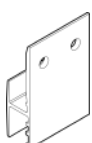

	PARTNUMBER	DESCRIPTION	UNIT
	A-FM10602925	ME 01 carrier profile 106/29/2,5mm, material EN AW 6063.T66, length 6.000mm	Rm.
	A-FM10602925.3000	ME 01 carrier profile 106/29/2,5mm, material EN AW 6063.T66, length 3.000mm	Rm.
	A-FM10602925.LL	ME 01 carrier profile 106/29/2,5mm, material EN AW 6063.T66, length 6.000mm, interval 80mm	Rm.
	A-FM10602925.3000.LL	ME 01 carrier profile 106/29/2,5mm, material EN AW 6063.T66, length 3.000mm, interval 80mm	Rm.
	A-FM08802445.60.20	ME 01 hanger fix from hanger profile 88,5/24/4,5mm, length: 60mm, 1 hole á 9,1mm, material EN AW 6063.T66, 250 pcs./box	Pcs.
	A-FM08802445.60.21	ME 01 hanger adjustable from hanger profile 88,5/24/4,5mm, length: 60mm, hole 9,1mm, thread M6, hole 5,1mm, material EN AW 6063.T66, 250 pcs./box	Pcs.
	A-FM08802445.60.22	ME 01 hanger fix from hanger profile 88,5/24/4,5mm, length: 60mm, 2 holes á 9,1mm, material EN AW 6063.T66, 250 pcs./box	Pcs.

Product List 2023. Prices in EUR exkl. 20% VAT subject to change without notice.

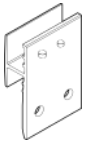
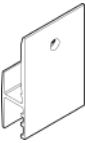
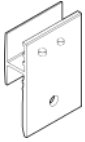
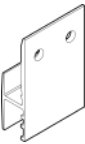
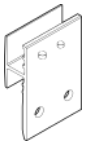

	PARTNUMBER	DESCRIPTION	UNIT
	A-FM08802445.60.23	ME 01 hanger adjustable from hanger profile 88,5/24/4,5mm, length: 60mm, 2 x hole á 9,1mm, thread M6, hole 5,1mm, material EN AW 6063.T66, 250 pcs./box	Pcs.
	A-FM08802445.60.30	ME 01 hanger fix from hanger profile 88,5/24/4,5mm, length: 60mm, hole 7,0mm, material EN AW 6063.T66, 180 pcs./box	Pcs.
	A-FM08802445.60.31	ME 01 hanger adjustable from hanger profile 88,5/24/4,5mm, length: 60mm, hole 7,0mm, thread M6, hole 5,1mm, material EN AW 6063 T66, 180 pcs./box	Pcs.
	A-FM08802445.60.32	ME 01 hanger fix from hanger profile 88,5/24/4,5mm, length: 60mm, 2 holes á 7,0mm, material EN AW 6063.T66, distance between holes 32mm, 100 pcs./box	Pcs.
	A-FM08802445.60.33	ME 01 hanger adjustable from hanger profile 88,5/24/4,5mm, length: 60mm, 2 holes á 7,0mm, distance between holes 32mm, thread M6, hole 5,1mm, material EN AW 6063.T66, 100 pcs./box	Pcs.

Product List 2023. Prices in EUR exkl. 20% VAT subject to change without notice.



ALLFACE
Smart Fixing Systems

IN.40

Product List 2023. Prices in EUR exkl. 20% VAT subject to change without notice.

Allface Befestigungstechnologie GmbH
www.allface.com

130/176

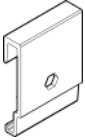
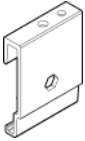
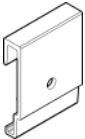
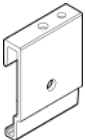
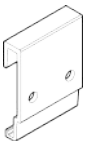

	PARTNUMBER	DESCRIPTION	UNIT
	A-C06501420.SL	C-carrier profile 65/14/2,0mm (IN.40), material EN AW 6063.T66, length 6.000mm including countersunk holes diameter 8mm, interval 300mm	Rm.
	A-C06601430.50.20	C-hanger fix 66/14/3,0mm (IN.40), length: 50mm, hexagon hole 9,2mm, material EN AW 6063.T66	Pcs.
	A-C06601430.50.21	C-hanger adjustable 66/14/3,0mm (IN.40), length: 50mm, hexagon hole 9,2mm, thread M6, hole d=5,1mm, material EN AW 6063.T66	Pcs.
	A-C06601430.50.30	C-hanger fix 66/14/3,0mm (IN.40), length: 50mm, hole 7,0mm centric, material EN AW 6063.T66	Pcs.
	A-C06601430.50.31	C-hanger adjustable 66/14/3,0mm (IN.40), length: 50mm, hole 7,0mm centric, thread M6, hole d=5,1mm, material EN AW 6063.T66	Pcs.
	A-C06601430.50.60	C-hanger fix 66/14/3,0mm (IN.40), length: 50mm, 2 holes 7,0mm, distance between holes 32mm, material EN AW 6063.T66	Pcs.

Product List 2023. Prices in EUR exkl. 20% VAT subject to change without notice.



ALLFACE
Smart Fixing Systems





Insulator pad F1

Product List 2023. Prices in EUR exkl. 20% VAT subject to change without notice.

Allface Befestigungstechnologie GmbH
www.allface.com

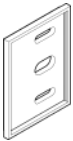
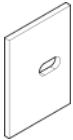
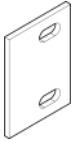
132/176



	PARTNUMBER	DESCRIPTION	UNIT
	I.F1.CNM	Insulator pad (not pre-assembled), suitable for bracket F1.D11, F1.D6,5, F1.D6,5X2, F1.X3, dimension: 71,2x97x5mm, material: PE, packing: 400 pcs./box	Pcs.
	I.F1.CAM	pre-assembled Insulator pad, suitable for bracket F1.D11, F1.D6,5, F1.D6,5X2, F1.X3, dimension: 71,2x97x5mm, material: PE	Pcs.
	I.F1	Insulator pad, suitable for bracket F1, dimension: 65x90x5mm, material: PVC, packing unit: 500 pcs./box	Pcs.
	I.F1X2	Insulator pad, suitable for bracket F1, 2 holes 22/6,5mm, dimension: 65x90x5mm, material: PVC, packing unit 500 pcs./box	Pcs.
	I+F1.CNM	Insulator pad (not pre-assembled), suitable for bracket F1+D11, F1+D6,5, F1+D6,5X3, F1+X5, dimension: 71,2x182x5mm, material: PE, packing: 200 pcs./box	Pcs.
	I+F1.CAM	pre-assembled Insulator pad, suitable for bracket F1+D11, F1+D6,5, F1+D6,5X3, F1+X5, dimension: 71,2x182x5mm, material: PE	Pcs.
	I+F1	Insulator pad, suitable for bracket F1+, dimension: 65x175x5mm, material: PVC, packing unit: 250 pcs./box	Pcs.

Product List 2023. Prices in EUR exkl. 20% VAT subject to change without notice.



ALLFACE
Smart Fixing Systems

Insulator pad F2

Product List 2023. Prices in EUR exkl. 20% VAT subject to change without notice.

Allface Befestigungstechnologie GmbH
www.allface.com

134/176

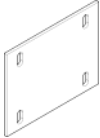

	PARTNUMBER	DESCRIPTION	UNIT
	I.F2	Insulator pad, suitable for bracket F2, dimension: 135x90x5mm, material: PVC, packing unit: 250 pcs./box	Pcs.
	I+F2	Insulator pad, suitable for bracket F2+, dimension: 135x175x5mm, material: PVC, packing unit: 125 pcs./box	Pcs.

Product List 2023. Prices in EUR exkl. 20% VAT subject to change without notice.



ALLFACE
Smart Fixing Systems





Insulator pad F3

Product List 2023. Prices in EUR exkl. 20% VAT subject to change without notice.

Allface Befestigungstechnologie GmbH
www.allface.com

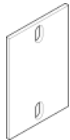
136/176



	PARTNUMBER	DESCRIPTION	UNIT
	I.F3.135090D11X2	Insulator pad, suitable for bracket F3.080(135).060.90D11X2, dimension: 135x90x5mm, material: PVC	Pcs.
	I+F3.135140D6,5	Insulator pad, suitable for bracket F3+080.060.140D6,5, dimension: 135x140x5mm, material: PVC	Pcs.
	I+F3.135200D11X2	Insulator pad, suitable for bracket F3+080.060.200D11x2, dimension: 135x200x5mm, material: PVC	Pcs.
	I+F3.135200D11X4	Insulator pad, suitable for bracket F3+080(135).060.200D11X4, dimension: 135x200x5mm, material: PVC	Pcs.
	I+F3.135200D6,5	Insulator pad, suitable for bracket F3+080.060.200D6,5, dimension: 135x200x5mm, material: PVC	Pcs.

Product List 2023. Prices in EUR exkl. 20% VAT subject to change without notice.



ALLFACE
Smart Fixing Systems



Insulator pad F4

Product List 2023. Prices in EUR exkl. 20% VAT subject to change without notice.

Allface Befestigungstechnologie GmbH
www.allface.com

138/176



	PARTNUMBER	DESCRIPTION	UNIT
	I.F4	Insulator pad, suitable for bracket F4, material: PVC	Pcs.
	I.F4.050X3	Insulator pad for F4.bracket, material: PVC, 2 fixing holes 22/6,5mm, 1x fixing holes 22/11mm, length 90mm, width 50mm, thickness 5mm	Pcs.
	I.F4.100X3	Insulator pad for F4.bracket, material: PVC, 2 fixing holes 22/6,5mm, 1x fixing holes 22/11mm, length 90mm, width 100mm, thickness 5mm	Pcs.
	I+F4	Insulator pad, suitable for bracket F4+, material: PVC	Pcs.
	I+F4.050X5	Insulator pad for F4+bracket, material: PVC, 3 fixing holes 22/6,5mm, 2 fixing holes 22/11mm, length 175mm, width 50mm, thickness 5mm	Pcs.
	I+F4.100X5	Insulator pad for F4+bracket, material: PVC, 3 fixing holes 22/6,5mm, 2 fixing holes 22/11mm, length 175mm, width 100mm, thickness 5mm	Pcs.

Product List 2023. Prices in EUR exkl. 20% VAT subject to change without notice.



ALLFACE
Smart Fixing Systems

Profiles for clip system

Product List 2023. Prices in EUR exkl. 20% VAT subject to change without notice.

Allface Befestigungstechnologie GmbH
www.allface.com

140/176



	PARTNUMBER	DESCRIPTION	UNIT
	A-FP04500958	joint profile for terracotta, dimension 45x9,5mm, material AlMg3, thickness 0,8mm, length 2.800mm	Rm.
	A-FP04502908.8	joint profile for terracotta with width of joint 7,5-8mm, dimension 45x29mm, material AlMg3, thickness 0,8mm, length 2.800mm	Rm.
	A-FP04503608.6	joint profile for terracotta with width of joint 6mm, dimension 45x36mm, material AlMg3, thickness 0,8mm, length 2.800mm	Rm.
	A-H09203018	Omega-profile 92/30/1,8mm, material EN AW 6063.T66, length 6.000mm	Rm.
	A-H09203018.LL	Omega-profile 92/30/1,8mm, material EN AW 6063.T66, length 6.000mm including elongated hole 6/20mm, interval 80mm	Rm.
	A-H11802520	Omega-profile (clamp) 118/25/2,0mm, material EN AW 6063.T66, length 6.000mm	Rm.
	A-H11802520.LL	Omega-profile (clamp) 118/25/2,0mm, material EN AW 6063.T66, length 6.000mm including elongated holes 6,7/20mm, interval 80mm	Rm.

Product List 2023. Prices in EUR exkl. 20% VAT subject to change without notice.



	PARTNUMBER	DESCRIPTION	UNIT
	A-H11803520	Omega-profile (clamp) 118/35/2,0mm, material EN AW 6063.T66, length 6.000mm	Rm.
	A-H11803520.LL	Omega-profile (clamp) 118/35/2,0mm, material EN AW 6063.T66, length 6.000mm including elongated holes 6,7/20mm, interval 80mm	Rm.
	A-L04907020	L-profile (clamp) 49/70/2,0mm, material EN AW 6063.T66, length 6.000mm	Rm.
	A-T11807020	T-profile (clamp) 118/70/2,0mm, material EN AW 6063.T66, length 6.000mm	Rm.
	A-Z06003018	Z-profile 36/30/37/1,8mm, material EN AW 6063.T66, length 6.000mm	Rm.
	A-Z06003018.LL	Z-profile 36/30/37/1,8mm, material EN AW 6063.T66, length 6.000mm including elongated hole 6/20mm, interval 80mm	Rm.

Product List 2023. Prices in EUR exkl. 20% VAT subject to change without notice.



ALLFACE
Smart Fixing Systems





Aluminium clips

Product List 2023. Prices in EUR exkl. 20% VAT subject to change without notice.

Allface Befestigungstechnologie GmbH
www.allface.com

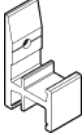

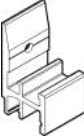

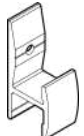
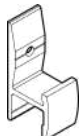
143/176

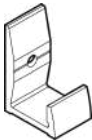
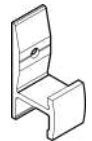
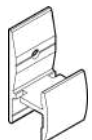
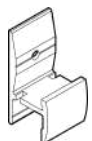

	PARTNUMBER	DESCRIPTION	UNIT
	K-KT05380315.20	T-clamp 53,8/31,5mm, material EN AW 6063.T66, length 20mm	Pcs.
	K-KT05380315.28K	T-clamp 53,8/31,5mm, material EN AW 6063.T66, length 28mm including notching	Pcs.
	K-KT05403025.28K	T-clamp TOB 54,0/33,25mm, material EN AW 6063.T66, length 28mm including notching	Pcs.
	K-KT05403025.28K.1	T-clamp TOB 54,0/33,25mm, material EN AW 6063.T66, length 28mm including notching, used as top clip	Pcs.
	K-KT05403025.28K.2	T-clamp TOB 54,0/33,25mm, material EN AW 6063.T66, length 28mm including notching, used as starter clip	Pcs.
	K-KT05702725.20	T-clamp 57/27/2,5mm, material EN AW 6063.T66, length 20mm	Pcs.
	K-KT05702725.20.1	T-clamp 57/27/2,5mm, material EN AW 6063.T66, length 20mm	Pcs.

Product List 2023. Prices in EUR exkl. 20% VAT subject to change without notice.



	PARTNUMBER	DESCRIPTION	UNIT
	K-KT05702725.20.2	T-clamp 57/27/2,5mm, material EN AW 6063.T66, length 20mm, used as starter clamp	Pcs.
	K-KT05702725.20.3	T-clamp 57/27/2,5mm, material EN AW 6063.T66, length 20mm	Pcs.
	K-KT05702725.28K	T-clamp 57/27/2,5mm, material EN AW 6063.T66, length 28mm including notching	Pcs.
	K-KT05702725.28K.1	T-clamp 57/27/2,5mm, material EN AW 6063.T66, length 28mm including notching	Pcs.
	K-KT05702725.28K.2	T-clamp 57/27/2,5mm, material EN AW 6063.T66, length 28mm including notching, used as starterclamp	Pcs.
	K-KT05702725.28K.3	T-clamp 57/27/2,5mm, material EN AW 6063.T66, length 28mm including notching	Pcs.
	K-KC07004730.30	clamp 70/47/3,0mm, material EN AW 6063.T66, length 30mm	Pcs.

Product List 2023. Prices in EUR exkl. 20% VAT subject to change without notice.



	PARTNUMBER	DESCRIPTION	UNIT
	K-KC07504030.25	clamp 75/40/3,0mm, material EN AW 6063.T66, length 25mm	Pcs.

Product List 2023. Prices in EUR exkl. 20% VAT subject to change without notice.



ALLFACE
Smart Fixing Systems

Stainless steel clips

Product List 2023. Prices in EUR exkl. 20% VAT subject to change without notice.

Allface Befestigungstechnologie GmbH
www.allface.com

147/176



	PARTNUMBER	DESCRIPTION	UNIT
	E-10020.D1	clamp with 4 lips 80/75/2,0mm for panel thickness 10mm, material stainless steel 1.4301	Pcs.
	E-10020.D2	clamp with 4 lips 80/75/2,0mm for panel thickness 10mm, material stainless steel 1.4301	Pcs.
	E-10020.D3	clamp with 2 lips 41/75/2,0mm for panel thickness 10mm, material stainless steel 1.4301	Pcs.
	E-10020.D4	clamp with 2 lips 41/75/2,0mm for panel thickness 10mm, material stainless steel 1.4301	Pcs.
	E-10020.D5	clamp with 2 lips 80/40/2,0mm for panel thickness 10mm, material stainless steel 1.4301	Pcs.
	E-10020.D6	clamp with 1 lip 42,5/40/2,0mm for panel thickness 10mm, material stainless steel 1.4301	Pcs.
	E-10020.D7	clamp with 2 lips 75/38/2,0mm for panel thickness 10mm, material stainless steel 1.4301	Pcs.

Product List 2023. Prices in EUR exkl. 20% VAT subject to change without notice.

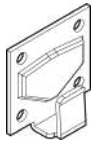

	PARTNUMBER	DESCRIPTION	UNIT
	E-10020.D8	clamp with 1 lip 42/38/2,0mm for panel thickness 10mm, material stainless steel 1.4301	Pcs.

Product List 2023. Prices in EUR exkl. 20% VAT subject to change without notice.



ALLFACE
Smart Fixing Systems

Primary fixings

Product List 2023. Prices in EUR exkl. 20% VAT subject to change without notice.

Allface Befestigungstechnologie GmbH
www.allface.com







150/176



	PARTNUMBER	DESCRIPTION	UNIT
	D-SXR10X60FUS	plastic frame anchor 10x60 with galvanized hexagon head screw, width across flat 13mm/T40	Pcs.
	D-SXR10X60FUS.A4	plastic frame anchor 10x60 with stainl.st. hexagon head screw, width across flat 13mm/T40	Pcs.
	D-SXR10X80FUS	plastic frame anchor 10x80 with galvanized hexagon head screw, width across flat 13mm/T40	Pcs.
	D-SXR10X80FUS.A4	plastic frame anchor 10x80 with stainl.st. hexagon head screw, width across flat 13mm/T40	Pcs.
	D-SXR10X100FUS	plastic frame anchor 10x100 with galvanized hexagon head screw, width across flat 13mm/T40	Pcs.
	D-SXR10X100FUS.A4	plastic frame anchor 10x100 with stainl.st. hexagon head screw, width across flat 13mm/T40	Pcs.
	D-SXR10X120FUS	plastic frame anchor 10x120 with galvanized hexagon head screw, width across flat 13mm/T40	Pcs.

Product List 2023. Prices in EUR exkl. 20% VAT subject to change without notice.



	PARTNUMBER	DESCRIPTION	UNIT
	D-SXR10X120FUS.A4	plastic frame anchor 10x120 with stainl.st. hexagon head screw, width across flat 13mm/T40	Pcs.
	D-SXR10X140FUS	plastic frame anchor 10x140 with galvanized hexagon head screw, width across flat 13mm/T40	Pcs.
	D-SXR10X160FUS	plastic frame anchor 10x160 with galvanized hexagon head screw, width across flat 13mm/T40	Pcs.
	D-SXR10X230FUS	plastic frame anchor 10x230 with galvanized hexagon head screw, width across flat 13mm/T40	Pcs.
	D-SXR10X260FUS	plastic frame anchor 10x260 with galvanized hexagon head screw, width across flat 13mm/T40	Pcs.
	D-SXRL10X80FUS	plastic frame anchor 10x80 (SXRL-FUS) with galvanized hexagon head screw, width across flat 13mm/T40	Pcs.
	D-SXRL10X80FUS.A4	plastic frame anchor 10x80 (SXRL-FUS A4) with stainl.st. hexagon head screw, width across flat 13mm/T40	Pcs.

Product List 2023. Prices in EUR exkl. 20% VAT subject to change without notice.



	PARTNUMBER	DESCRIPTION	UNIT
	D-SXRL10X100FUS	plastic frame anchor 10x100 (SXRL-FUS) with galvanized hexagon head screw, width across flat 13mm/T40	Pcs.
	D-SXRL10X100FUS.A4	plastic frame anchor 10x100 (SXRL-FUS A4) with stainl.st. hexagon head screw, width across flat 13mm/T40	Pcs.
	D-SXRL10X120FUS	plastic frame anchor 10x120 (SXRL-FUS) with galvanized hexagon head screw, width across flat 13mm/T40	Pcs.
	D-SXRL10X120FUS.A4	plastic frame anchor 10x120 (SXRL-FUS A4) with stainl.st. hexagon head screw, width across flat 13mm/T40	Pcs.
	D-RD1000600SKS.VZ	plastic frame anchor 10x60 with galvanized hexagon head screw, width across flat 13mm, especially for concrete wall	Pcs.
	D-RDD1001000SKS.VZ	universal plastic frame anchor 10x100 with galvanized hexagon head screw, width across flat 13mm	Pcs.
	D-RDD1001200SKS.VZ	universal plastic frame anchor 10x120 with galvanized hexagon head screw, width across flat 13mm	Pcs.





Product List 2023. Prices in EUR exkl. 20% VAT subject to change without notice.



	PARTNUMBER	DESCRIPTION	UNIT
	Z-9650005112	anchor bolt BA-E 8/10, 50 pcs./box	Pcs.
	Z-9650005135	anchor bolt BA-E 10/20, 25 pcs./box	Pcs.
	Z-9650005312	anchor bolt BA-E Plus 8/30, 50 pcs./box	Pcs.
	Z-9650005136	anchor bolt BA-E 10/30, 25 pcs./box	Pcs.
	Z-FIS501396	Fischer anchor bolt FAZ II 8/10 A4, 50 pcs./box	Pcs.
	Z-FIS501398	Fischer anchor bolt FAZ II 8/10 GS A4, 50 pcs./box	Pcs.
	Z-FIS501399	Fischer anchor bolt FAZ II 8/30 A4, 50 pcs./box	Pcs.

Product List 2023. Prices in EUR exkl. 20% VAT subject to change without notice.

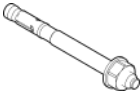

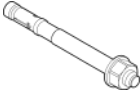
	PARTNUMBER	DESCRIPTION	UNIT
	Z-FIS501403	Fischer anchor bolt FAZ II 10/10 A4, 50 pcs./box	Pcs.
	Z-FIS501406	Fischer anchor bolt FAZ II 10/20 A4, 50 pcs./box	Pcs.
	Z-FIS501407	Fischer anchor bolt FAZ II 10/30 A4, 50 pcs./box	Pcs.
	Z-FIS501415	Fischer anchor bolt FAZ II 12/20 A4, 20 pcs./box	Pcs.
	Z-FIS501416	Fischer anchor bolt FAZ II 12/30 A4, 20 pcs./box	Pcs.

Product List 2023. Prices in EUR exkl. 20% VAT subject to change without notice.



ALLFACE
Smart Fixing Systems

Screws

Product List 2023. Prices in EUR exkl. 20% VAT subject to change without notice.

Allface Befestigungstechnologie GmbH
www.allface.com







156/176

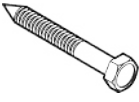

	PARTNUMBER	DESCRIPTION	UNIT
	S-LK0480250.A2	self drilling screw 4,8x25, DIN 7504, material A2	Pcs.
	S-SKT0490700.A2	self drilling screw 4,9x70 incl. sealing washer with hexagon head, width across flat 8mm, material A2	Pcs.
	S-SKT0550220.16.A2	self drilling screw 5,5x22 incl. sealing disc E16 with hexagon head, width across flat 8mm, material A2	Pcs.
	S-SKT0550220.16.A4	self drilling screw 5,5x22 incl. sealing disc E16 with hexagon head, width across flat 8mm, material A4	Pcs.
	S-SKT0600300.A2	hexagon head screw M6x30, DIN 933, material A2-70	Pcs.
	S-SKT0600300.A4	hexagon head screw M6x30, DIN 933, material A4	Pcs.
	S-SKT0600300.A4.12	hexagon head screw M6x30, DIN 931, material A4, length of thread 12mm, 200 pcs./box	Pcs.

Product List 2023. Prices in EUR exkl. 20% VAT subject to change without notice.

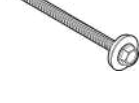

	PARTNUMBER	DESCRIPTION	UNIT
	S-SKT0600460.16.A2	self drilling screw 6,0x46 incl. sealing disc E16, with hexagon head, width across flat 8mm, material A2 (bi-metal), 500 pcs./box	Pcs.
	S-SKT0600460.16.A4	self drilling screw 6,0x46 incl. sealing disc E16, with hexagon head, width across flat 8mm, material A4	Pcs.
	S-SKT0600500.A2	hexagon head wood screw 6,0x50, width across flat 13mm, material A2	Pcs.
	S-SKT0650500.A2	sealed screw 6,5x50 E16 (JA3 6,5x50 E16) with hexagon head, width across flat 8mm, material A2	Pcs.
	S-SKT0650650.A2	self drilling screw 6,5x65 with hexagon head, width across flat 8mm, material A2, 250 pcs./box	Pcs.
	S-SKT0650750.A2	sealed screw 6,5x75 E16 with hexagon head, width across flat 8mm, material A2	Pcs.
	S-SKT0650800.A2	self drilling screw 6,5x80 with hexagon head, width across flat 8mm, material A2	Pcs.

Product List 2023. Prices in EUR exkl. 20% VAT subject to change without notice.



	PARTNUMBER	DESCRIPTION	UNIT
	S-SKT4480190.A2.W	self drilling screw 4,8x19 with hexagon head, width across flat 8mm, clamping range 11mm, material A2, 500 pcs./carton	Pcs.

Product List 2023. Prices in EUR exkl. 20% VAT subject to change without notice.



ALLFACE
Smart Fixing Systems



Facade screws

Product List 2023. Prices in EUR exkl. 20% VAT subject to change without notice.

Allface Befestigungstechnologie GmbH
www.allface.com

160/176



	PARTNUMBER	DESCRIPTION	UNIT
	FS-48550120.A2	facade screw 4,8x55mm, head 12mm, Torx T20, 250 pcs/carton, uncoated	Pcs.
	FS-48550120L.A2	facade screw 4,8x55mm, head 12mm, Torx T20, 250 pcs./carton, coloured	Pcs.
	FS-55350120.A4	facade screw 5,5x35mm, head 12mm, Torx T20, 250 pcs./carton, uncoated	Pcs.
	FS-55350120L.A4	facade screw 5,5x35mm, head 12mm, Torx T20, 250 pcs./carton, coated	Pcs.
	FS-55400160.A4	facade screw 5,5x40mm, head 16mm, Torx T20, 100 pcs./carton, uncoated	Pcs.
	FS-55400160L.A4	facade screw 5,5x40mm, head 16mm, Torx T20, 100 pcs./carton coated	Pcs.
	FS-55450120.A4	facade screw 5,5x45mm, head 12mm, Torx T20, 250 pcs./carton, uncoated	Pcs.

Product List 2023. Prices in EUR exkl. 20% VAT subject to change without notice.



	PARTNUMBER	DESCRIPTION	UNIT
	FS-55450120L.A4	facade screw 5,5x45mm, head 12mm, Torx T20, 250 pcs./carton, coated	Pcs.

Product List 2023. Prices in EUR exkl. 20% VAT subject to change without notice.



ALLFACE
Smart Fixing Systems

Rivets

Product List 2023. Prices in EUR exkl. 20% VAT subject to change without notice.

Allface Befestigungstechnologie GmbH
www.allface.com

163/176



	PARTNUMBER	DESCRIPTION	UNIT
	N-50100095.AN	Alu/Stainless steel rivet 5,0x10,0mm head 9,5mm, grip range 0-6,5mm, blank, packing 1.000 pcs/carton	Pcs.
	N-50100140.AN	Alu/Stainless steel rivet 5,0x10,0mm head 14,0mm, grip range 2,0-5,0mm, blank, 250 pcs./box	Pcs.
	N-50120140.AN	Alu/Stainless steel rivet 5,0x12,0mm head 14,0mm, grip range 4,0-7,0mm, blank	Pcs.
	N-50120140L.AN	Alu/Stainless steel rivet 5,0x12,0mm head 14,0mm, grip range 4,0-7,0mm, coloured	Pcs.
	N-50160140.AN	Alu/Stainless steel rivet 5,0x16,0mm head 14,0mm, grip range 7,0-10,5mm, uncoated	Pcs.
	N-50160140L.AN	Alu/Stainless steel rivet 5,0x16,0mm head 14,0mm, grip range 7,0-10,5mm, coloured, packing: 250 pcs./box	Pcs.
	N-50180140.AN	Alu/Stainless steel rivet 5,0x18,0mm head 14,0mm, grip range 9-12,5mm, blank	Pcs.

Product List 2023. Prices in EUR exkl. 20% VAT subject to change without notice.



	PARTNUMBER	DESCRIPTION	UNIT
	N-50180140L.AN	Alu/Stainless steel rivet 5,0x18,0mm head 14,0mm, grip range 9-12,5mm, coloured, packing 250 pcs./carton	Pcs.
	N-50180160.AN	Alu/Stainless steel rivet 5,0x18,0mm head 16,0mm, grip range 9-12,5mm, blank	Pcs.
	N-50180160L.AN	Alu/Stainless steel rivet 5,0x18,0mm head 16,0mm, grip range 9-12,5mm, coloured	Pcs.
	N-50210140.AN	Alu/Stainless steel rivet 5,0x21,0mm head 14,0mm, grip range 12,0-15,5mm, blank	Pcs.
	N-50210140L.AN	Alu/Stainless steel rivet 5,0x21,0mm head 14,0mm, grip range 12,0-15,5mm, coloured	Pcs.
	N-50210160L.AN	Alu/Stainless steel rivet 5,0x21,0mm head 16,0mm, grip range 12,0-15,5mm, coloured	Pcs.
	N-50230140.AN	Alu/Stainless steel rivet 5,0x23,0mm head 14,0mm, grip range 14,0-17,5mm, blank	Pcs.

Product List 2023. Prices in EUR exkl. 20% VAT subject to change without notice.



	PARTNUMBER	DESCRIPTION	UNIT
	N-50230140L.AN	Alu/Stainless steel rivet 5,0x23,0mm head 14,0mm, grip range 14,0-17,5mm, coloured	Pcs.
	N-50250140.AN	Alu/Stainless steel rivet 5,0x25,0mm head 14,0mm, grip range 15,5-19,5mm	Pcs.
	N-50250140L.AN	Alu/Stainless steel rivet 5,0x25,0mm head 14,0mm, grip range 15,5-19,5mm, coloured	Pcs.
	N-50250160L.AN	Alu/Stainless steel rivet 5,0x25,0mm head 16,0mm, grip range 15,5-19,5mm, coloured	Pcs.

Product List 2023. Prices in EUR exkl. 20% VAT subject to change without notice.



ALLFACE
Smart Fixing Systems







Accessories

Product List 2023. Prices in EUR exkl. 20% VAT subject to change without notice.

Allface Befestigungstechnologie GmbH
www.allface.com

167/176



	PARTNUMBER	DESCRIPTION	UNIT
	S-PT0600095.A4	Duro-PT screw S6,0x9,5mm, TX30, material A4	Pcs.
	S-PT0600110.A4	Duro-PT screw S6,0x11,5mm, TX30, material A4	Pcs.
	S-PT0600145.A4	Duro-PT screw S6,0x14,5mm, TX30, material A4	Pcs.
	Z-B7555432200	Keil spacer 15x6/7,5	Pcs.
	Z-B7555432202	Keil spacer 15x6,5/8	Pcs.
	Z-BSM06DIN125.A2	washer M6 acc. DIN 125, material A2, 1.000 pcs./carton	Pcs.
	Z-BSM06DIN125.A4	washer M6 acc. DIN 125, material A4, 1.000 pcs./carton	Pcs.





Product List 2023. Prices in EUR exkl. 20% VAT subject to change without notice.

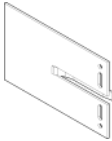

	PARTNUMBER	DESCRIPTION	UNIT
	Z-BSM06DIN440.A2	washer M6 acc. DIN 440, material A2, 500 pcs./carton	Pcs.
	Z-BSM06DIN9021.A2	washer M6 acc. DIN 9021, material A2, 500 pcs./carton	Pcs.
	Z-BSM07DIN9021.A2	washer M7 acc. DIN 9021, material A2, 500 pcs./carton	Pcs.
	Z-BSM08DIN125.A2	washer M8 acc. DIN 125, material A2, 1.000 pcs./box	Pcs.
	Z-BSM08DIN125.A4	washer M8 acc. DIN 125, material A4, 1.000 pcs./carton	Pcs.
	Z-BSM10DIN125.A2	washer M10 acc. DIN 125, material A2, 500 pcs./carton	Pcs.
	Z-BSM10DIN440.A2	washer M10 acc. DIN 440, material A2, 100 pcs./carton	Pcs.

Product List 2023. Prices in EUR exkl. 20% VAT subject to change without notice.



	PARTNUMBER	DESCRIPTION	UNIT
	Z-BSM12DIN125.A2	washer M12 acc. DIN 125, material A2, 500 pcs./carton	Pcs.
	Z-DS09014025	extension piece 90/140/2,5mm suitable for F1/F2, material: ALMG3 F22	Pcs.
	Z-DS17514025	extension piece 175/140/2,5mm suitable for F1+/F2+, material: ALMG3 F22	Pcs.
	Z-FH0606100	Fischer Tergo+ 11x6 M6/T/10 PA, material PA+A4, packing: 250 pcs./carton	Pcs.
	Z-FIS511440	Fischer anti corrosion spray FTC-CP	Pcs.
	Z-FZP090090.A4	Fischer undercutting anchor 9x9 N 2,0 material A4	Pcs.
	Z-FZP090110.A4	Fischer undercutting anchor 9x11 N 2,0, material A4	Pcs.

Product List 2023. Prices in EUR exkl. 20% VAT subject to change without notice.



	PARTNUMBER	DESCRIPTION	UNIT
	Z-KH0406085.A4	undercutting anchor typ AA, depth 4,0mm, screw M6x8,5, material A4	Pcs.
	Z-KH0556085.A4	undercutting anchor typ AA, depth 5,5mm, screw M6x8,5, material A4	Pcs.
	Z-KH0556115.A4	undercutting anchor typ AA, depth 5,5mm, screw M6x11,5, material A4	Pcs.
	Z-KH0706100.A4	undercutting anchor typ AA, depth 7,0mm, screw M6x10,0, material A4	Pcs.
	Z-KH0706130.A4	undercutting anchor typ AA, depth 7,0mm, screw M6x13,0, material A4	Pcs.
	Z-KH0856115.A4	undercutting anchor typ AA, depth 8,5mm, screw M6x11,5, material A4	Pcs.
	Z-KH0856130.A4	undercutting anchor typ AA, depth 8,5mm, screw M6x13,0, material A4	Pcs.







Product List 2023. Prices in EUR exkl. 20% VAT subject to change without notice.

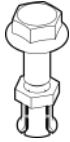

	PARTNUMBER	DESCRIPTION	UNIT
	Z-KH0856145.A4	undercutting anchor typ AA, depth 8,5mm, screw M6x14,5, material A4	Pcs.
	Z-KH0856160.A4	undercutting anchor typ AA, depth 8,5mm, screw M6x16,0, material A4	Pcs.
	Z-KH0856175.A4	undercutting anchor typ AA, depth 8,5mm, screw M6x17,5, material A4	Pcs.
	Z-KH0856250.A4	undercutting anchor typ BH, depth 8,5mm, incl. headless pin M6x25 and screw nut, material A4	Pcs.
	Z-KH1006130.A4	undercutting anchor typ AA, depth 10,0mm, screw M6x13,0, material A4	Pcs.
	Z-KH1506175.A4	undercutting anchor typ AA, depth 15,0mm, screw M6x17,5, material A4	Pcs.
	Z-KH1506205.A4	undercutting anchor typ AA, depth 15,0mm, screw M6x20,5, material A4	Pcs.

Product List 2023. Prices in EUR exkl. 20% VAT subject to change without notice.

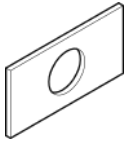

	PARTNUMBER	DESCRIPTION	UNIT
	Z-KH1506235.A4	undercutting anchor typ AA, depth 15,0mm, screw M6x23,5, material A4	Pcs.
	Z-KH1506255.A4	undercutting anchor typ AA, depth 15,0mm, screw M6x26 (attention: screw is shortened to 25,5mm), material A4	Pcs.
	Z-KH1506260.A4	undercutting anchor typ AA, depth 15,0mm, screw M6x26, material A4	Pcs.
	Z-TUS6X11	hidden fastener TUF-S-6x11-A4	Pcs.
	Z-TUS6X13	hidden fastener TUF-S-6x13-A4	Pcs.
	Z-TUS6X9	hidden fastener TUF-S-6x9-A4	Pcs.
	Z-ZG02605020	neoprene ZKNE 221 R black, 26/50/2mm with 1 hole diameter 16mm, packing: 1 coil á 380 pcs.	Pcs.

Product List 2023. Prices in EUR exkl. 20% VAT subject to change without notice.

GENERAL CONDITIONS OF SALE AND SUPPLY OF THE ALLFACE Befestigungstechnologie GmbH FN 278890h

We produce - and will produce - our deliveries and services exclusively on the basis of the following terms of supply and business. Any deviation from them is valid only, if this has been explicitly agreed in writing. Any contrary terms of business by the customer have not been agreed, even if orders or other kinds of written documents refer to them and are not explicitly contradicted by us in particular cases.

1. CONTRACTUAL RELATIONSHIP

Any statements in offers, price lists, catalogues, advertisements, sales promotions as well as in samples for inspection are always subject to confirmation and are without obligation.

A contractual relationship materialises only after our written confirmation of an order. Any omission of discussion does not count as an agreement. Any deviation from the order in our confirmation of the order must be the subject of an immediate complaint in writing; otherwise any legal action is excluded. After previous written agreement, regular customers' orders can be confirmed by us orally/by telephone.

2. PRICES

Only the prices specified in our confirmation of the order are valid.

Orders made/confirmed orally are regarded as posted on the day of order, according to the corresponding list price.

A cash discount on list prices is allowed only on the explicit condition that all the invoices have been paid entirely and in due time.

All quoted prices are exclusive of the legal sales tax.

3. SUPPLY

If not agreed otherwise, delivery takes place ex works. The unloading is always the responsibility of and at the risk of the customer.

We are entitled to deliver in parts.

We endeavour to meet the delivery date notified by us. However, we do not guarantee our delivery dates, even if confirmed by us. Any problem with delivery for which we are not responsible, including any possible delay in delivery by our suppliers, authorise us to extend our delivery time or to withdraw from the contract. Any claim for compensation by the purchaser because of delayed or omitted delivery is excluded in any case.

4. CONDITIONS OF PAYMENT

If not agreed otherwise, payment is due within 7 days from invoice date, net without cash discount.

We are not obliged to accept a bill or a cheque; payments are treated as made only when payment is received in our bank account. Any costs connected with the transfer of funds are chargeable to the purchaser.

In case of default of payment, interest at the rate of 8 percentage points above the base interest rate specified by the Austrian National Bank, are agreed. The minimum rate will be 10% per annum. Furthermore, in case of default of payment, the purchaser is committed to reimbursing us for our expenses regarding the collection of the debt, according to the fees and expenses, defined by the Austrian Rechtsanwaltsstarifgesetz (Lawyers' Pay Act) and the Austrian Gerichtsgebührengesetz (Court Costs Act).

The purchaser is not entitled to deduct his own claims against us from the invoice in respect of the purchase price. Neither is the purchaser entitled to withhold due payments because of alleged warranty claims. The purchaser is not allowed to transfer his title to claims towards us to a third party.

5. RESERVATION OF PROPRIETARY RIGHTS

We always supply with the explicit reservation that the delivered goods remain our property, until our invoice in respect of the purchase price has been paid off in its entirety.

With the diligence of a prudent businessman the purchaser must

In case of default of payment the purchaser commits himself, on our first request, to disclosing to us the purchasers of the goods specified under this condition as well as their insurers.

The purchaser is prohibited from mortgaging the goods specified under this condition or the claims transferred to us, from transferring his ownership as security on a debt, or from selling it to a third party, otherwise than as agreed in this contract, as long as our invoice in respect of the purchase price has not been entirely paid off.

Compulsory possession orders and other attempts to gain access to the goods specified under this condition by a third party that affect our legal status have immediately to be reported to us in writing. The purchaser has promptly to object to such measures, in so far as they relate to our conditional property.

6. WARRANTY AND LIABILITY

Complaints about obvious faults must be made in writing immediately upon receipt of the goods; otherwise any legal action is excluded. The warranty period shall be limited to six months from the date of delivery. Complaints about hidden faults must be made in writing immediately, upon their discovery and must include an accurate description of the fault. Any claim regarding quantity or quality that is justifiably raised will be settled consensually between our customers and us, according to existing commercial practice. However, claims for damages on account of the non-performance of a supply contract are excluded.

If our delivered products are based on installation plans (installation guidelines and technical information) drawn up by ALLFACE, you have to follow strictly these installation plans (installation guidelines and technical information). The installation plans (installation guidelines and technical information), created by ALLFACE, have been drawn up on the basis of data supplied by you. ALLFACE will not verify the accuracy of your data. Therefore we assume no liability for data supplied by you to ALLFACE. In this regard any warranty claims and claims for damages by you are excluded *a priori*. ALLFACE is not liable for quality defects and incorrect technical specifications that are the fault of the suppliers of the materials. Neither do we accept any liability for defects resulting from failure to comply with our installation plans (installation guidelines and technical information) or with customs and practices, generally accepted in the trade.

We warrant the quality of the products on the basis of the specifications and test standards, stated in the product range. There is no implied warranty of fitness for certain applications. We specifically are not liable for faults arising from modification or wear and tear, for defects in the supporting construction or the installation, or for damage brought about by the incorrect processing (installation) of any item.

For items produced externally we are liable only on the basis of the warranty, guaranteed by the particular producer.

Except in cases based on intention or gross negligence, no further liability, including liability to pay compensation, is accepted. Excluded in particular is any compensation for consequential loss, for other indirect damages, or loss, or loss of profit due to bad delivery, default of delivery, or delay in delivery. In any case, our liability (regarding the amount due) is limited to the total value of the particular order.

7. COURT OF JURISDICTION, APPLICABLE LAW, MISCELLANEOUS

Regarding any disputes resulting from or in connection with the

keep goods specified under this condition separate from other goods and to ensure them sufficiently against all risks.

The purchaser is allowed to process the goods specified under this condition in the framework of normal course of business and/or to sell them. This further processing shall take place in our interests and shall not lead to the loss of our property. In case of incorporation or amalgamation with other goods that are not our property, we shall be credited with co-ownership, proportional to the quota.

By the terms of this contract, the purchaser has transferred to us all of his claims against a third party resulting from the resale of the goods specified under this condition, as well as all claims resulting from insurance contracts, up to a maximum of the purchase price as specified in our invoice. The purchaser has to keep incoming money from the paid, third party invoices separate from his own money, and immediately to pass it on to us, as soon as our invoice in respect of the purchase price falls due. We consent to this resale and, as a concession, we commit ourselves not to collect the resulting payments from the third parties until our invoice in respect of the original purchase price falls due.

business connection, the court of jurisdiction is Wiener Neustadt exclusively. The language of the contract as well as at court shall be German.

We are also entitled to institute proceedings against the purchaser, in our sole discretion and at our own discretion at the purchaser's place of general jurisdiction.

Austrian law shall apply. The application of the UN purchase law is excluded.

The fact of single clauses not being operative does not touch on the effectivity of the other clauses of these conditions of sale and supply. Should we choose not to exercise any single right, or all the rights to which we are herein entitled, this shall not mean a relinquishment of these rights.

The place of performance is Leobersdorf.

August 2006

